



**MKF**

**MOSKABEL-  
FUJIKURA**

# CATALOGUE

**FIBER-OPTICAL CABLES**

**COMBINED  
COMMUNICATION CABLES**

**EQUIPMENT  
FOR INSTALLATION  
OF FIBER-OPTICAL CABLES**



**2020-2021**

# CONTENTS

About us	3
Testing laboratory and quality control	6
Transportation and storage	7
Cable drums, types, length of optical cable on drums	8
Optical fiber, types and characteristics	10
Backbone and backhaul optical cables	12
Labeling of backbone and backhaul optical cables	13
Direct buried optical cables (OKGMd, OKGTSd, OKGM, OKGTS)	14
Optical cables for laying in cable cannels (OKKM, OKKTS)	18
Optical cables for laying in plastic pipes (OKTM, OKTTS)	20
All Dielectric Self-Supporting optical cables (OKSM, OKSMs, OKSD, OKSTS)	22
Suspension optical cables with integrated messenger (OKPM, OKPP)	26
Suspension optical cables all dielectric flat (OKPP)	28
Combined optical + power cables	29
Labeling of combined optical cables	30
Combined optical cables for direct bury (KSPP OKGM)	31
Combined optical cables for laying in cable cannels (KSPP OKKM)	32
Combined optical cables for laying in plastic pipes (KSPP OKTM)	33
Suspension combined optical cables with integrated messenger (KSPP OKPM)	34
Combined optical cables self-supporting, protected (SIP-3/OM, SIP-3/OTS)	35
Optical cables for LANs	36
Labeling of optical cables for LANs	37
Distribution (OKR)	38
Riser (OKV)	40
Drop cable and drop cable with messenger (OKDP)	42
Simplex, Duplex (OKS, OKD)	44
Equipment for installation of optical cables	45
Accessories for suspension cables	46
Optical closures	48
Optical distribution frames	49
Optical cords, Measuring instruments	50
Contacts	

# OBJECTS OF MOSKABEL-FUJIKURA

To supply customers with competitive products of steady high quality for successful business.



## BASIC PRINCIPLES OF OUR COMPANY:



### **CUSTOMER FOCUS**

We pay utmost attention to requirements of our customers. High-quality Russian product meets the highest international standards with reasonable prices. It gives our customers the chance to decrease costs without affecting quality.



### **CONFIDENCE OF CLIENTS**

We adhere to the principles of honesty and transparency in dealing with our customers and partners. One of main tasks of our Company is to build-up trust and reliable relations with our clients.



### **CONTINUING IMPROVEMENTS**

We strive for innovations and improvements of technology and logistics. We promote professional growth of our staff.





## PRODUCTS

MKF technologies allow manufacturing optical cables containing up to 1152 optical fibers, with tensile force up to 100kN.

MKF develops new designs and manufactures optical cables with due regard to special requirements of the customers.

Optical cable made by MKF is included into the list of electronic component base and is admitted to supplies for the Ministry of Defense of the Russian Federation.

In accordance with modern requirements to fire safety, optical cables can be made with Halogen Free Low Smoke sheath and Fire Resistant (LSZH, LTx, FR).



## ABOUT US

Joint stock company MOSKABEL-FUJIKURA (JSC MKF) was founded by CJSC MOSKABELMET jointly with FUJIKURA Ltd. on 9th of September 1999. JSC MKF focused on production of optical cables for backbone optical networks, backhaul networks and LANs.

The annual production capacity is up to 35,000 kilometers.



## CLIENTS

Consumers of MKF products are ROSTELECOM, MTS, TRANSNEFT, MEGAFON, ROSNEFT, LUKOIL, MOSCOW METRO, all main airports, national operator of Belorussia BELTELECOM, the Ministry of Defence of the Russian Federation, and many others.





## MACHINERY

MOSKABEL-FUJIKURA uses modern machinery by leading European manufacturers:

- NEXTROM (Finland)
- SWISSCAB (Switzerland)
- MAILLEFER (Finland)
- MALI (Austria)
- ROSENDAHL (Austria)
- DUNST (Austria)
- MEDEK&SCHORNER (Austria)
- SKET

## RAW MATERIALS

Materials used for production:

- FUJIKURA Ltd. (Japan)
- BOREALIS (Finland)
- DUPONT (the USA)
- HERKULA (Germany)

and of many other well-known European manufacturers. Moskabel-Fujikura uses optical fiber by Fujikura Ltd (Japan) or, upon customer's requirements, optical fiber by other manufacturers.

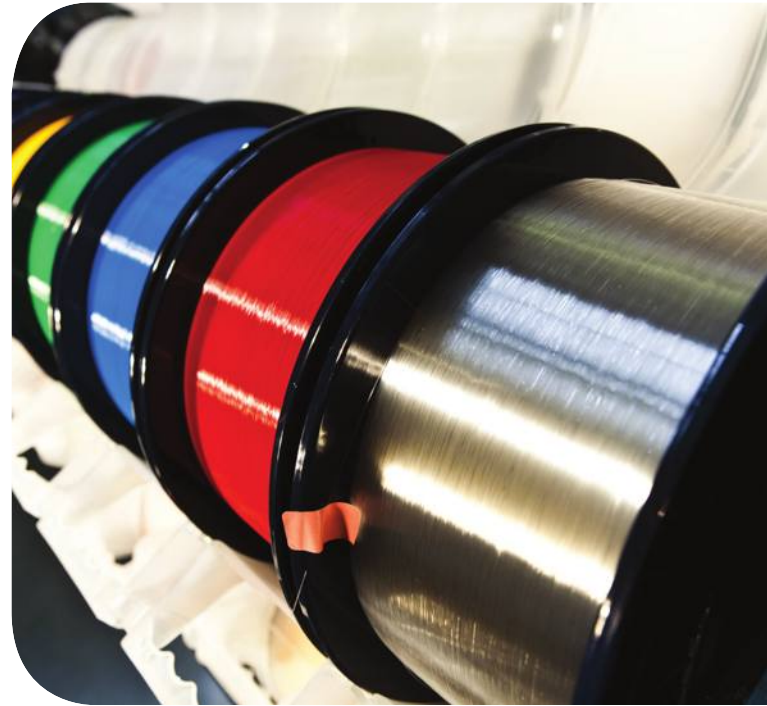

## QUALITY MANAGEMENT SYSTEM

The company has developed, implemented and successfully operates a quality management system covering the entire process from cables designing and purchasing materials to acceptance testing and delivery of products to the customer.

The Quality Management System of the enterprise was certified:

- in the system of voluntary certification "AFNOR and IQNet", Certificate of Conformity of the QMS to requirements of ISO 9001-2015
- in the system of voluntary certification "REGISTER OF MANAGEMENT SYSTEMS", Certificate of Conformity of the QMS to requirements of ISO 9001-2015
- Ecological Management System that complies with requirements of ISO 14001-2015 (ISO 14001:2016) has been implemented and successfully functions at the enterprise with the aim of protecting the environment and health.

Optical cables manufactured by JSC MKF also have:

- the conclusion of ROSSETI on the conformity of OKSD (ADSS tracking resistant) cable to the technical requirements of ROSSETI (the largest power grid company in the world).

## TESTING LABORATORY AND QUALITY CONTROL

### Equipment used for incoming control:



The breaking machine **INSPEKT** is designed to control the quality of strength members of cables, such as aramid filament, steel wire, glass-reinforced plastic (FRP) rods, steel strand.



The moisture meter **AND MS-70** makes it possible to control moisture content in materials during production process.



Heat chamber **HERAEUS** allows to control the quality of polymers and semi-products used in production of fiber optical cables through thermal testing up to + 300°C.



The instrument **SWO HAAKE** for measuring melt fluidity indicator is used to prove the quality of polymers used in production.

### The following equipment is used to control the quality of finished products:

- Climatic chamber **CLIMATS 8M** makes possible testing fiber optical cables in the temperature range from -60°C to 70°C with humidity of up to 98%;
- **FA-10** by **SWISSCAB** allows testing the cable for resistance to tensile stress up to 100 kN and crushing force to 1.5 kN /cm;
- Samples of the cable are tested for resistance to mechanical stress - twisting, bending, impact;
- **EXFO multi-module measuring platform FTB-500** - for measuring polarization-mode and chromatic dispersion, reflectometry (OTDR) and dispersion (CD, PMD) measurements of optical fiber.
- The lab is also equipped with **ID-2-3B** – device for measuring fiber elongation during tests for resistance of optical cables to tension;
- Our lab is equipped with a unique instrument – optical fiber strain analyzer **BOTDR AQ8603** designed for finding and analysis of mechanical strain fibers in optical cable during manufacturing process, during installation and service of an entire communication line. Measuring results make it possible to forecast fiber life cycle, that is the entire communication line.





## USEFUL INFORMATION

### CONDITIONS OF TRANSPORTATION, UNLOADING AND STORAGE OF OPTICAL CABLE

#### 1. REQUIREMENTS FOR TRANSPORTATION OF DRUM WITH CABLE

- 1.1 The cable must be transported in accordance with the requirements of GOST 18690-2012.
- 1.2 Conditions of cables transportation as regard to climatic factors must correspond to the conditions of storage 8 (OJZ) in accordance with GOST 15150.
- 1.3 It is prohibited to transport drums with wound cable flat-wise (on drum flange).
- 1.4 The manufacturer's warranty does not apply to cable transported in violation of the above items.

#### 2. REQUIREMENTS FOR UNLOADING OF DRUM WITH CABLE

- 2.1 Optical cable is a fragile commodity, as evidenced by the special marking "Fragile. Caution" on drum flange. While the unloading, it is necessary to protect the cable drum against external mechanical influence like impacts, vibration, etc.
- 2.2 While unloading, it is allowed to roll drum only in the direction indicated by the arrow on the outer side of the drum flange.
- 2.3 Cable should be unloaded from the vehicle with a forklift or lifting equipment.
- 2.4 If a mechanized method of unloading cable drums is impossible, it is allowed to roll out drums on the gangway with the help of a slings. Manual drums unloading by rolling them is allowed on condition that warehouse floor is at the same level with the floor of the car body or the wagon. If the warehouse floor is below the floor of the wagon or the car body, drums may be unloaded manually on thick poles or a gangway by two workers using strong ropes. By that the possibility of falling or hitting the drum with wound cable should be completely ruled out.
- 2.5 To throw off a drum with wound cable from the car body to the ground is strictly prohibited!

#### 3. INCOME CONTROL AND PROCEDURE IN CASE OF NON-CONFORMANCE

- 3.1 After receiving cable the Buyer will carry out income control

according to the acceptance tests stipulated by the specifications mentioned in the supporting documentation.

3.2 The Buyer has the right to conduct additionally other tests stipulated by the specifications.

3.3 In case of non-conformance the Buyer prepares and sends AO MKF a claim containing: the name of Buyer's organization, drum number, cable length, nature of non-conformity, date of finding of non-conformity, trade mark of the equipment and procedures measurements (tests).

3.4 Latent faults of the product may be found by the Buyer in the course of laying and installation of the cable. In this case the procedure is similar to that one described in section 3.3.

#### 4. STORAGE OF DRUMS WITH CABLE

4.1 Conditions of storage of cables must correspond to storage conditions 5 (OJ4) according to GOST 15150-69.

4.2 Optical cable must be stored in Supplier's packing at a place away from direct sunrays.

#### 5. SAFETY REQUIREMENTS

The staff who deals with packing, loading, transportation, unloading, acceptance, storage, laying, and installation of optical cable must comply with the safety requirements stipulated by the internal documents of the organization responsible for these works.

#### 6. MANUFACTURER'S WARRANTY

6.1 The manufacturer guarantees conformance of cables to requirements of specifications stated in the supporting documentation, subject to the Buyer's compliance with the conditions of transportation, unloading, storage, installation and operation.

The warranty period is two (2) years from the date of commissioning, but not more than three (3) years from the date of delivery, unless otherwise specified in the contract.



## USEFUL INFORMATION

### DIMENSIONS AND WEIGHT OF CABLE DRUMS

Dimensions of types of wooden drums and standard construction lengths given below will help you to determine optimal loading of vehicles.

Optical cables for backbone communication networks are supplied on wooden drums with regard to the ordered construction length. Drums are made in accordance with Russian National Standard GOST 18690; that ensures reliable protection of cable during transportation and storage.

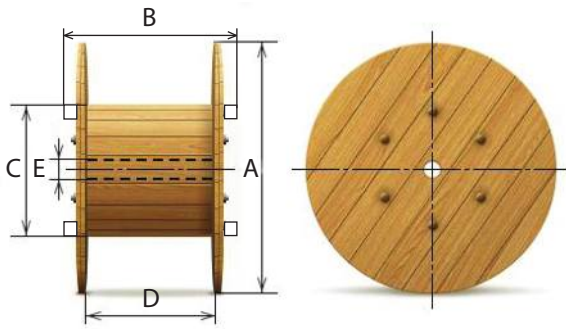

Type of drums	Dimensions of a wooden drum, mm					Weight of drum with cover, kg
	A	B	C	D	E	
8a	800	520	450	400	50	50
10a	1000	864	500	710	50	95
12a	1220	864	650	710	70	127
14	1400	875	750	710	70	175
14r	1400	1065	750	900	70	207
16a	1600	970	800	800	80	249
17a	1700	1094	900	900	80	323
18a	1800	1120	900	900	80	434

Optical cables for LANs are supplied on plywood drums or in coils with regard to an ordered construction length. Package of plywood drums with polymer mats or film ensures reliable protection of cables.

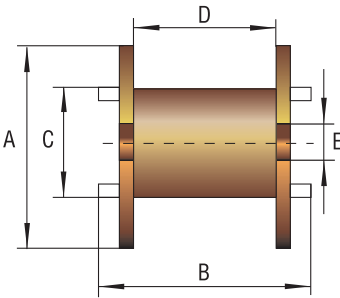

Type of drums	Dimensions of plywood drums, mm					Weight of drum with cover, kg
	A	B	C	D	E	
500	496	270	182	250	81	3.9
600	600	430	252	400	81	10.4
750	750	576	350	530	81	17.4

## LENGTH OF OPTICAL CABLE WOUND ON PLYWOOD DRUMS

The below tables give max. length of winding of optical cables on various types of drums depending on the diameter of optical cable.

### For lan optical cables on plywood drums

Diameter of optical cable, mm	Length of optical cable on a plywood drum, km		
	500	600	750
3	3.8	8.6	14.3
3.5	2.8	6.3	10.6
4.0	2.1	4.8	8.2
4.5	1.7	3.8	6.5
5.0	1.4	3.1	5.3
5.5	1.1	2.5	4.4
6.0	0.9	2.1	3.7



## USEFUL INFORMATION

### LENGTH OF WINDING OF OPTICAL CABLES ON WOODEN DRUMS

The table gives max. lengths of winding of optical cable on various types of drums depending on the diameter of the optical cable. Cable length is given in km. The sign "-" means that it is not recommended to wind cable of a given diameter on the given type of the drum, as bending radius of the cable will be less than 20 diameters of the cable.

#### For optical cables with round cross-section

Diameter of optical cable, mm	Length of optical cable on a wooden drum, km							
	8a	10a	12a	14	14r	16a	17a	18a
6.0	2.7	8.8	12.8	17.0	21.5	26.8	32.7	38.5
6.5	2.3	7.5	10.9	14.5	18.4	22.9	27.9	32.9
7.0	2.0	6.5	9.4	12.5	15.9	19.8	24.1	28.4
7.5	1.8	5.7	8.2	10.9	13.9	17.2	21.1	24.8
8.0	1.6	5.0	7.2	9.6	12.2	15.2	18.5	21.8
8.5	1.4	4.4	6.4	8.5	10.8	13.5	16.4	19.4
9.0	1.2	4.0	5.7	7.6	9.7	12.0	14.7	17.3
9.5	1.1	3.6	5.2	6.9	8.7	10.8	13.2	15.5
10.0	1.0	3.2	4.7	6.2	7.9	9.8	11.9	14.0
10.5	0.9	2.9	4.2	5.6	7.1	8.9	10.8	12.7
11.0	0.8	2.7	3.9	5.1	6.5	8.1	9.9	11.6
11.5	-	2.4	3.5	4.7	6.0	7.4	9.0	10.6
12.0	-	2.2	3.2	4.3	5.5	6.8	8.3	9.8
12.5	-	2.1	3.0	4.0	5.0	6.3	7.7	9.0
13.0	-	-	2.8	3.7	4.7	5.8	7.1	8.3
13.5	-	-	2.6	3.4	4.3	5.4	6.6	7.7
14.0	-	-	2.4	3.2	4.0	5.0	6.1	7.2
14.5	-	-	2.2	3.0	3.8	4.7	5.7	6.7
15.0	-	-	2.1	2.8	3.5	4.4	5.3	6.3
15.5	-	-	2.0	2.6	3.3	4.1	5.0	5.9
16.0	-	-	1.8	2.4	3.1	3.8	4.7	5.5
16.5	-	-	-	2.3	2.9	3.6	4.4	5.2
17.0	-	-	-	2.2	2.7	3.4	4.2	4.9
17.5	-	-	-	2.0	2.6	3.2	3.9	4.6
18.0	-	-	-	1.9	2.4	3.0	3.7	4.4
18.5	-	-	-	1.8	2.3	2.9	3.5	4.1
19.0	-	-	-	-	2.2	2.7	3.3	3.9
19.5	-	-	-	-	2.1	2.6	3.2	3.7
20.0	-	-	-	-	2.0	2.5	3.0	3.5
20.5	-	-	-	-	-	2.3	2.9	3.4
21.0	-	-	-	-	-	2.2	2.7	3.2

#### For optical cables with an outer strength member

Dimensions of optical cables, mm*	Length of optical cable on a wooden drum, km*							
	8a	10a	12a	14	14r	16a	17a	18a
5.7 x 11.9	1.4	4.4	6.3	8.4	10.7	13.3	16.2	15.3
5.7 x 12.5	1.3	4.2	6.0	8.0	10.2	12.7	15.5	14.6
5.7 x 13.1	1.2	4.0	5.8	7.7	9.7	12.1	14.8	14.0
9.5 x 19.5	0.5	1.7	2.4	3.2	4.1	5.1	6.2	7.3
10.3 x 20.3	0.5	1.5	2.1	2.9	3.6	4.5	5.5	6.5
10.7 x 20.7	0.4	1.4	2.0	2.7	3.4	4.3	5.2	6.1
11.5 x 21.5	-	1.3	1.8	2.4	3.1	3.8	4.7	5.5
13.2 x 23.2	-	-	1.5	2.0	2.5	3.1	3.8	4.5
16.5 x 26.5	-	-	-	1.4	1.8	2.2	2.7	3.2

# OPTICAL FIBER

JSC MKF uses for cable production optical fiber manufactured by FUJIKURA Ltd. (Japan) or if requested by the customer, optical fiber made by other manufacturers could be used.

Optical fibers comply with Recommendations of ITU-T: G.651, G.652, G.653, G.654, G.655, G.657, and other international standards.

At the request of the customer, it is possible to manufacture a cable with any type of optical fiber.

## PARAMETERS AND TYPES OF SINGLE-MODE OPTICAL FIBERS

Geometric and transmitting parameters of optical fiber		ITU-T G.652.D+ G.657.A1 (E3)	ITU-T G.652.D (E3)	ITU-T G.655 (E5)	ITU-T G.657.A1	ITU-T G.657.A2
Operating wavelength, nm		1310, 1383, 1550, 1625	1310, 1383, 1550	1550, 1625	1310, 1383, 1550, 1625	1310, 1383, 1550, 1625
	1310 nm	0.32	0.35	-	0.35	0.35
Attenuation coefficient at reference wavelength, dB/km, not more than	1383 nm	0.31	0.31	-	0.35	0.35
	1550 nm	0.18	0.18	0.20	0.21	0.22
	1625 nm	0.2	-	0.22	0.23	0.24
Diameter of mode field, $\mu\text{m}$	1310 nm	9.2 $\pm$ 0.4	9.2 $\pm$ 0.4	-	8.6 $\pm$ 0.4	8.6 $\pm$ 0.4
	1550 nm	10.4 $\pm$ 0.5	10.4 $\pm$ 0.8	9.6 $\pm$ 0.4	-	-
Cladding diameter, $\mu\text{m}$		125.0 $\pm$ 0.7	125.0 $\pm$ 1.0	125.0 $\pm$ 1.0	-	-
Non-concentricity of fiber core and cladding, $\mu\text{m}$		0.5	0.5	0.6	0.5	0.5
Coating diameter, $\mu\text{m}$		240 $\pm$ 5	240 $\pm$ 5	245 $\pm$ 10	240 $\pm$ 5	
Cutoff wavelength, nm		1260	1260	1480	1260	1260
Wavelength of zero dispersion, nm		1302-1324	1300-1324			
Zero dispersion slope, ps/(nm <sup>2</sup> x km)		0.092	0.092	-	0.092	0.092
Coefficient of chromatic dispersion, ps/(nm <sup>2</sup> x km)	1310 nm	<3.5	<3.5		<3.5	
	1550 nm	<18	<18	2.0-6.0	<18	
Coefficient of polarization mode dispersion, ps/km		0.04	0.08	0.10	0.2	0.2

## PARAMETERS AND TYPES OF MULTIMODE OPTICAL FIBERS

Geometrical and transmission parameters of optical fibers		IEC60793-2-10 (OM1/M2)	ITU-T G.651.1 (OM2/M1)	ITU-T G.651.1 (OM3/M3)	ITU-T G.651.1 (OM4/M4)
Operating wavelength, nm		850/1300	850/1300	850/1300	850/1300
Coefficient of attenuation at reference wavelength, dB/km, not more than	850 nm	2.9	2.9	2.3	2.3
	1300 nm	0.6	0.6	0.6	0.6
Core diameter, $\mu\text{m}$		62.5 $\pm$ 2.5	50 $\pm$ 2.5	50.0 $\pm$ 2.5	50.0 $\pm$ 2.5
Cladding diameter, $\mu\text{m}$		125.0 $\pm$ 2.0	125.0 $\pm$ 1.0	125.0 $\pm$ 1.0	125.0 $\pm$ 1.0
Non-concentricity of fiber core and cladding, $\mu\text{m}$		3.0	1.5	1.5	1.5
Coating diameter, $\mu\text{m}$		245 $\pm$ 10	245 $\pm$ 10	245 $\pm$ 10	245 $\pm$ 10
Bandwidth 850 nm/1300 nm, MHz/km		200/500	500/500	1500/500	3500/500
Numerical aperture		0.275 $\pm$ 0.015	0.200 $\pm$ 0.015	0.200 $\pm$ 0.015	0.200 $\pm$ 0.015



Types of optical fibers in cable designations	General characteristic of optical fibers
E3 / G.652.D+G.657.A1	Single-mode fiber with low-peak water optimized at wavelengths 1310, 1550, 1625 and 1383 nm according to recommendations ITU-TG.652.D, reduced radius of bending according to recommendation ITU-TG.657.A1
E3 / G.652.D	Single-mode fiber with low-peak water optimized at wavelengths 1310, 1550 and 1383 nm according to recommendation ITU-TG.652.D
E5 / G.655	Single-mode fiber with shifted non-zero dispersion optimized at wavelengths 1550 и 1625 nm according to recommendation ITU-TG.655
G.657.A1	Single-mode fiber with reduced radius of bending according to recommendation ITU-TG.657.A1, has additional requirements as to losses at bends with radius of 15 mm
G.657.A2	Single-mode fiber with reduced bending radius according to recommendation ITU-TG.657.A2, has additional requirements as to losses at bends with radius of 7.5 mm
OM1/ M2	Multimode fiber 62.5/125 with coefficient of wideband 500 MHz/km at wavelength 850 nm
OM2/ M1	Multimode fiber 50/125 with coefficient of wideband 500 MHz/km at wavelength 850 nm according to recommendation ITU-TG.651.1
OM3/ M3	Multimode fiber 50/125 with coefficient of wideband 1500 MHz/km at wavelength 850 nm according to recommendation ITU-TG.651.1
OM4/ M4	Multimode fiber 50/125 with coefficient of wideband 3500MHz/km at wavelength of 850 nm according to recommendation ITU-TG.651.1

## STANDARD COLOR IDENTIFICATION OF OPTICAL FIBERS IN TUBES

Number of fibers in a tube	2	4	6	8	10	12	16	24
Color of a fiber in a tube	Natural	Natural	Natural	Natural	Natural	Natural	Natural	Natural
	Red	Red	Red	Red	Red	Red	Red	Red
		Dark blue	Dark blue	Dark blue	Dark blue	Dark blue	Dark blue	Dark blue
		Green	Green	Green	Green	Green	Green	Green
			Yellow	Yellow	Yellow	Yellow	Yellow	Yellow
			Purple	Purple	Purple	Purple	Purple	Purple
				Orange	Orange	Orange	Orange	Orange
				Grey	Grey	Grey	Grey	Grey
					Blue	Blue	Blue	Blue
					Black	Black	Black	Black
					Brown	Brown	Brown	
					Pink	Pink	Pink	
Color of ring marking of fibers in tubes							Natural	Natural
							Red	Red
							Dark blue	Dark blue
							Green	Green
								Yellow
								Purple
								Orange
								Grey
								Blue
								White
							Brown	
							Pink	

Custom coloring is available, including IEC standard or P1222.



# BACKBONE AND BACKHAUL OPTICAL CABLES



# LABELING OF BACKBONE AND BACKHAUL OPTICAL CABLES

## Optical cables for underground laying

**OKGM, OKGTS** are designed for direct bury in soils of all categories, in cable channels, pipes, blocks, collectors, tunnels and shafts, in water when crossing swamps and non-navigable rivers.

**OKKM, OKKTS** are designed for installation in cable channels, pipes, blocks, collectors, tunnels, along bridges, and in shafts.

## Aerial optical cables

**OKSM, OKSTS** are designed for overhead suspension on poles of communication grids, contact networks of railways and of town electric transport, overhead radio transmission lines, poles of street lights, between buildings and structures. **OKSD** is designed for overhead suspension on aerial power grids and contact networks of railways.

**OKPM, OKPTS** are designed for overhead suspension on supports of communication grids, poles of street lights, between buildings and structures.

**OKPP** is designed for overhead suspension on aerial power grids, poles of street lights, contact networks of town transport, supports of radio transmission lines, between buildings and structures, in cable channels, along building fronts.

## Optical cables for installation in plastic pipes and for indoor installation

**OKTM** is designed for laying in plastic pipes.

**OKTTS** is designed for laying in cable channels, inside buildings and structures.

STRUCTURE OF LABELING OF BACKBONE AND BACKHAUL OPTICAL CABLES							
OK	G	M	ng(A)	- HF	-01	-3x4E3/...*	-(7,0) -T**
							<b>Allowable tensile force (static), kN</b>
							<b>Number of OF x number of optical fibers in a tube</b>
							<b>Type of optical fiber:</b>
							E3 - single-mode OF with low-water peak according to ITU-TG.652.D, with reduced radius of bending according to ITU-TG.657.A1; or single-mode OF with low-water peak according to ITU-TG.652.D
							E5 - single-mode OF with non-zero shifted dispersion according to recommendation ITU-TG.655
							M1 (OM2) – multimode OF 50/125 according to recommendation ITU-TG.651.1
							M2 (OM1) - multimode OF 62.5/125 according to recommendation IEC60793-2-10
							M3 (OM3) - multimode OF 50/125 according to recommendation ITU-TG.651.1
							M4 (OM4) - multimode OF 50/125 according to recommendation ITU-TG.651.1
							<b>Designs:</b>
							00 - single-tube, no central strength member
							01 - multi-tube, central strength member (or outer strength member for OKPM and OKPTS) – one or two (for cables OKPP) with FRP rods
							02 - multi-tube, central strength member or outer strength member (for OKPM and OKPTS) – steel strand
							03 - multi-tube, central strength member or outer strength member (for OKPM and OKPTS) – steel wire
							04 - multi-tube, outer strength member for OKPM and OKPTS – aramid filament
							<b>Cable with PE fire-retardant sheath:</b>
							n - in individual laying
							ng(A) - in bundle laying
							ng(A) - LS – in bundle laying, with low liberation of smoke and gas
							ng(A) - HF – in group laying, without liberation of corrosive gaseous products when burning and smoldering (halogen-free)
							ng(A)-FR – fire resistant, flame-retardant in bundle laying
							ng(A)-LTx- flame-retardant in bundle laying, with low toxicity of combustion products
							<b>Type of design:</b>
							M - loose tube design
							TS - design with a central tube
							P - flat
							D - dielectric (certified by Federal network company ROSSETI, for suspension on power lines)
							d - dielectric (armor made of FRP rods for cables OKGMd, OKGTSd)
							s - only for self-supporting cable, design with glass filament (OKSMs).
							<b>Type of laying:</b>
							G - optical cable for direct bury.
							K - optical cable for laying in channels.
							P - suspension optical cable.
							S - self-supporting optical cable.
							T - optical cable for laying in pipes.
<b>Optical cable</b>							

Footnotes: \* - When different types of optical fiber (E3...M2) are used, number of fibers of each type in tubes is given separately, T – outer sheath of OKSD is made of tracking-resistant PE. **Abbreviations:** PE – polyethylene, OF – optical fiber, FRP – fiber-reinforced plastic.

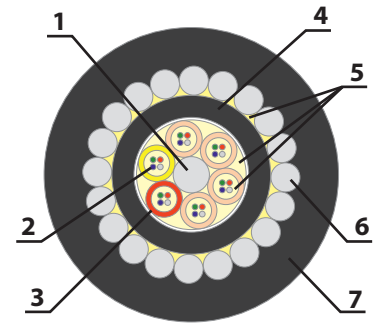
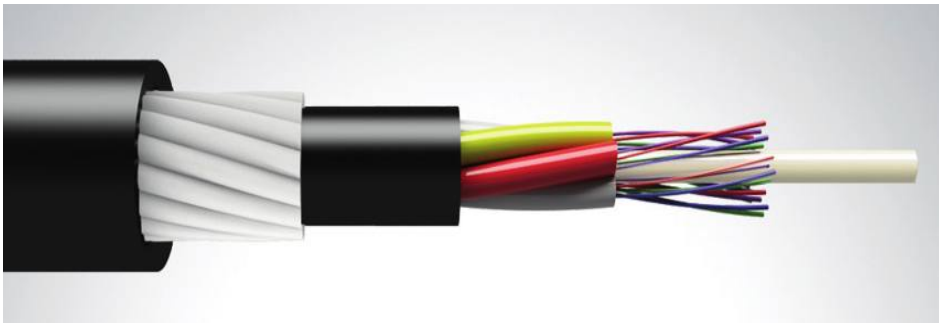

### Key characteristics



Crushing force  
from 400 N/cm



Tensile force  
up to 80 kN



Operating temperature  
from -60°C to 70°C  
Installation: up to -30°C



For any  
climatic  
zones



Fire-safe



Rodent protection



100% dielectric

### Application

The cable is designed for direct bury, for cable channels, pipes, blocks, collectors, tunnels, shafts, in water when crossing swamps, lakes, and rivers

### Technical characteristics

Number of OF in a cable	Number of OF in a tube	Nominal calculated cable diameter, mm	Calculated cable weight, kg/km	Tensile force, kN	Min. radius of cable bending, mm
-------------------------	------------------------	---------------------------------------	--------------------------------	-------------------	----------------------------------

#### OKGMd(n)-01-1x4...12x24...-(7.0)

Up to 48	Up to 12	12.2	Up to 156	7.0	244
Up to 64	Up to 8	13.6	Up to 179		272
Up to 96	Up to 12	15.9	Up to 211		318
Up to 144	Up to 12	19.5	Up to 290		390
Up to 288	Up to 24	26.9	Up to 553		538

Custom design is available.

### Design

1. Central strength element - FRP rod.
2. Optical fiber.
3. Tube.
4. PE intermediate sheath.
5. Gel filler.
6. Round FRP rods.
7. Outer PE sheath.

### Certificates

- Declaration of conformity for cables type OKGMd
- Fire safety certificates for cables type OKGMd in categories:  
-n, -ng(A), -ng(A)-HF, -ng(A)-LS, -ng(A)-FR, -ng(A)-LTx, -ng(A)-FRHF, -ng(A)-FRLS, -ng(A)-HFLT, -ng(A)-LSLT, -ng(A)-FRHFLT, -ng(A)-FRLSLTx.



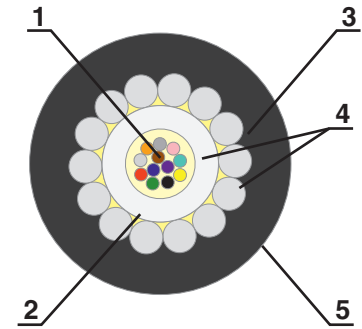
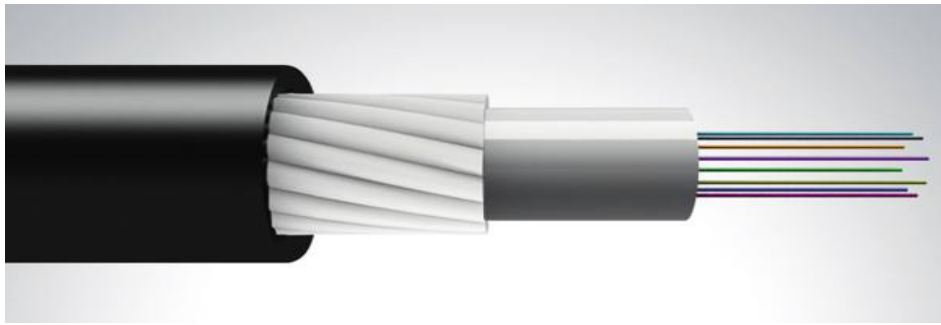

### Key characteristics



Crushing force  
from 400 N/cm



Tensile force  
up to 80 kN



Operating temperature  
from -60°C to 70°C  
Installation: up to -30°C



For any  
climatic  
zones



Fire-safe



Rodent protection



100% dielectric

### Application

The cable is designed for direct bury, for cable channels, pipes, blocks, collectors, tunnels, shafts, in water when crossing swamps, lakes, and rivers.

### Design

1. Optical fiber.
2. Central tube.
3. Round FRP rods.
4. Gel filler.
5. Outer PE sheath.

### Certificates

- Declaration of conformity for cables type OKGTSd
- Fire safety certificates for cables type OKGTSd in categories:  
-n, -ng(A), -ng(A)-HF, -ng(A)-LS,  
-ng(A)-FR, -ng(A)-LTx, -ng(A)-FRHF,  
-ng(A)-FRLS, -ng(A)-HFLT<sub>x</sub>, -ng(A)-LSLT<sub>x</sub>,  
-ng(A)-FRHFLT<sub>x</sub>, -ng(A)-FRLSLT<sub>x</sub>.

### Technical characteristics

Number of OF in a cable	Nominal calculated cable diameter, mm	Calculated cable weight, kg/km	Tensile force, kN	Min. radius of cable bending, mm
<b>OKGTSd(n)-00-1x4...1x48...-(4.0)</b>				
Up to 24	7.6	Up to 56	4.0	152
Up to 48	10.2	Up to 205		204
<b>OKGTSd(n)-00-1x4...1x48...-(8.0)</b>				
Up to 24	9.9	Up to 100	8.0	198
Up to 48	11.0	Up to 268		220
<b>OKGTSd-00-1x4...1x48...-(20.0)</b>				
Up to 24	14.6	Up to 210	20.0	292
Up to 48	14.6	Up to 220		292

Custom design is available.

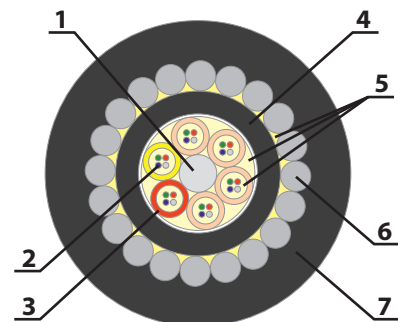
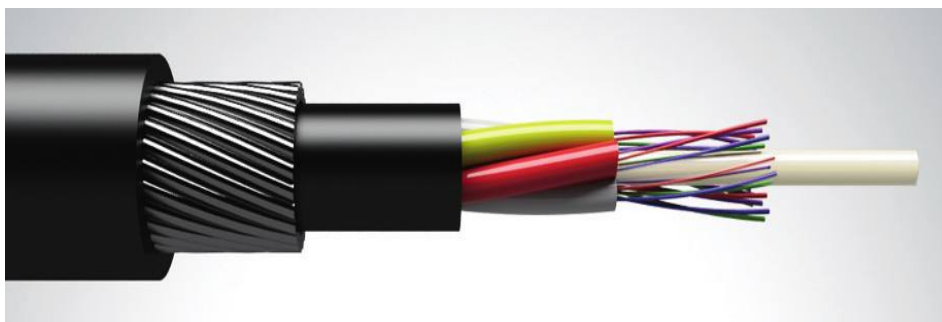

### Key characteristics



Crushing force  
from 400 N/cm



Tensile force  
up to 80 kN



Operating temperature  
from -40°C to 70°C  
Arctic version from -60°C to 70°C  
Installation: up to -30°C



For any climatic  
zones



Fire-safe



Rodent protection

### Application

The cable is designed for direct bury, in cable channels, pipes, blocks, collectors, tunnels, shafts, in water when crossing swamps, lakes, and rivers.

### Technical characteristics

Number of optical fibers in cable	Number of optical fibers in a tube	Nominal calculated cable diameter, mm	Calculated cable weight, kg/km	Tensile force, kN	Min. radius of cable bending, mm
<b>OKGM(n)-01-1x4...12x24...-(7.0)</b>					
Up to 48	Up to 12	12.2	Up to 258	7.0	244
Up to 64	Up to 8	13.6	Up to 321		272
Up to 96	Up to 12	15.9	Up to 477		318
Up to 144	Up to 12	19.5	Up to 756		390
Up to 288	Up to 24	26.9	Up to 1449		538
<b>OKGM(n)-02-1x4...12x24...-(7.0)</b>					
Up to 64	Up to 12	13.6	Up to 252	7.0	272
Up to 96	Up to 12	15.2	Up to 482		304
Up to 144	Up to 12	17.9	Up to 761		358
Up to 288	Up to 24	26.9	Up to 1453		538
<b>OKGM-01-1x4...12x12...-(20.0)</b>					
Up to 48	Up to 12	14.8	Up to 357	20.0	296
Up to 64	Up to 8	16.3	Up to 487		326
Up to 96	Up to 12	17.8	Up to 564		356
Up to 144	Up to 12	21.3	Up to 850		426
<b>OKGM-01-1x4...12x12...-(80.0)</b>					
Up to 64	Up to 8	21.5	Up to 905	80.0	430
Up to 96	Up to 12	23.3	Up to 980		466

Custom design is available.

### Design

1. Central strength member - FRP rod, steel strand or steel wire in PE sheath.
2. Optical fiber.
3. Tube.
4. Intermediate PE sheath.
5. Gel filler.
6. Round steel wire.
7. Outer PE sheath.

### Certificates

- Declaration of conformity for cables type OKGM
- Fire safety certificates for cables type OKGM in categories:  
-n, -ng(A), -ng(A)-HF, -ng(A)-LS, -ng(A)-FR, -ng(A)-LTx, -ng(A)-FRHF, -ng(A)-FRLS, -ng(A)-HFLTx, -ng(A)-LSLTx, -ng(A)-FRHFLTx, -ng(A)-FRLSLTx.

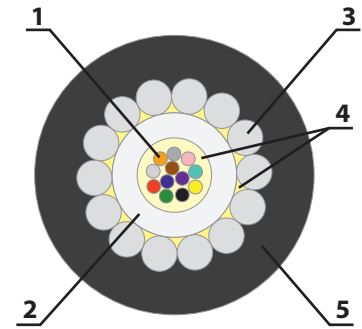
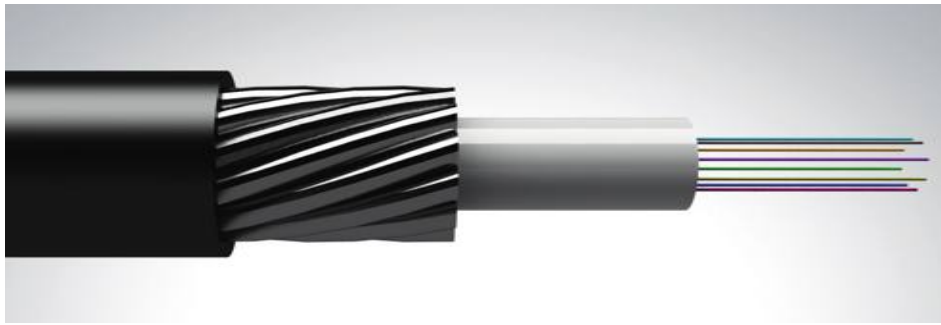

### Key characteristics



Crushing force  
from 400 N/cm



Tensile force  
up to 80 kN



Operating temperature  
from -40°C to 70°C  
Arctic version from -60°C to 70°C  
Installation: up to -30°C



For any climatic  
zones



Fire-safe



Rodent protection

### Application

The cable is designed for direct bury, cable channels, pipes, blocks, collectors, tunnels, shafts, in water when crossing swamps, lakes, and rivers.

### Technical characteristics

Number of fibers in cable	Nominal calculated cable diameter, mm	Calculated cable weight, kg/km	Tensile force, kN	Min. radius of cable bending, mm
<b>OKGTS(n)-00-1x4...1x48...(4.0)</b>				
Up to 24	7.6	Up to 95	4.0	152
Up to 48	10.2	Up to 205		204
<b>OKGTS(n)-00-1x4...1x48...(8.0)</b>				
Up to 24	7.6	Up to 95	8.0	152
Up to 48	11.0	Up to 268		220
<b>OKGTS-00-1x4...1x48...(20.0)</b>				
Up to 24	11.8	Up to 289	20.0	236
Up to 48	12.0	Up to 285		240
<b>OKGTS-00-1x4...1x48...(80.0)</b>				
Up to 24	18.0	Up to 794	80.0	360
Up to 48	20.2	Up to 856		404

Custom design is available.

### Design

1. Optical fiber.
2. Central tube.
3. Round steel wire.
4. Gel filler.
5. Outer PE sheath.

### Certificates

- Declaration of conformity for cables type OKGTS
- Fire safety certificates for cables type OKGTS in categories:  
-n, -ng(A), -ng(A)-HF, -ng(A)-LS, -ng(A)-FR, -ng(A)-LTx, -ng(A)-FRHF, -ng(A)-FRLS, -ng(A)-HFLTx, -ng(A)-LSLTx, -ng(A)-FRHFLTx, -ng(A)-FRLSLTx



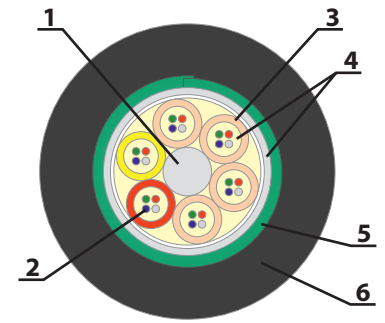
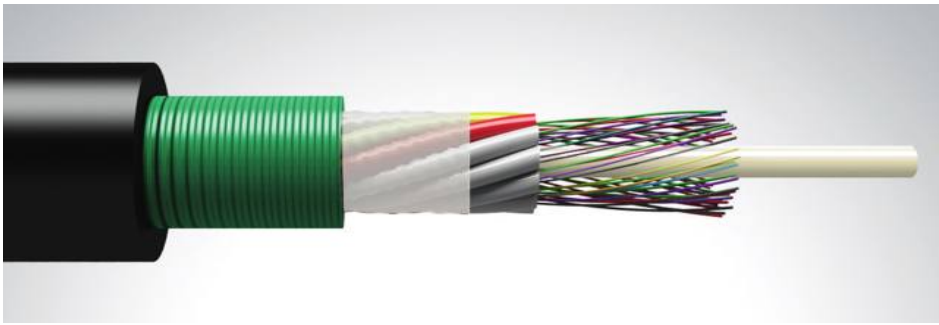

### Key characteristics



Crushing force  
300 N/cm and more



Tensile force  
up to 4 kN



Operating temperature  
from -40°C to 70°C  
Installation: up to -30°C



Fire-safe



Rodent protection

### Application

The cable is designed for installation in cable channels, pipes, blocks, collectors, tunnels, along bridges and in shafts.

### Technical characteristics

Number of optical fibers in cable	Number of optical fibers in a tube	Nominal calculated cable diameter, mm	Calculated cable weight, kg/km	Tensile force, kN	Min. radius of cable bending, mm
<b>OKKM(n)-01-1x4...16x36...(2.7)</b>					
Up to 48	Up to 8	10.2	Up to 106	2.7	204
Up to 64	Up to 8	11.0	Up to 122		220
Up to 72	Up to 12	11.3	Up to 129		226
Up to 96	Up to 12	12.5	Up to 148		250
Up to 144	Up to 12	15.1	Up to 209		302
Up to 288	Up to 24	21.7	Up to 422		434
Up to 576	Up to 36	23.2	Up to 445		464
<b>OKKM(n)-02-1x4...16x36...(2.7)</b>					
Up to 64	Up to 8	11.8	Up to 138	2.7	236
Up to 72	Up to 12	12.6	Up to 156		252
Up to 96	Up to 12	13.2	Up to 168		264
Up to 144	Up to 12	15.8	Up to 236		316
Up to 288	Up to 24	21.7	Up to 427		434
Up to 576	Up to 36	23.2	Up to 455		464

Custom design is available.

### Design

1. Central strength member - FRP rod, steel strand or steel wire in PE sheath (or without it).
2. Optical fiber.
3. Tube.
4. Water-blocking tape.
5. Steel corrugated tape.
6. Outer PE sheath.

### Certificates

- Declaration of conformity for cables type OKKM
- Fire safety certificates for cables type OKKM in categories:  
-n, -ng(A), -ng(A)-HF, -ng(A)-LS, -ng(A)-FR, -ng(A)-LTx, -ng(A)-FRHF, -ng(A)-FRLS, -ng(A)-HFLTx, -ng(A)-LSLTx, -ng(A)-FRHFLTx, -ng(A)-FRLSLTx.

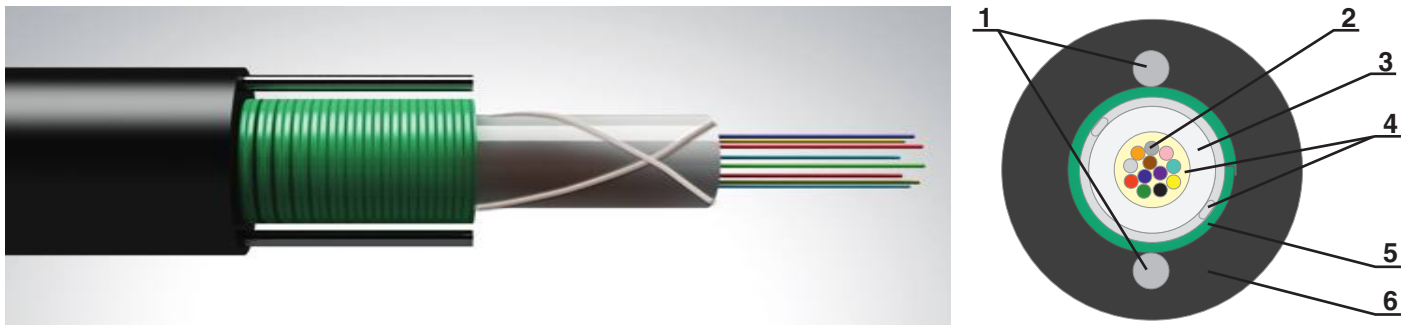

### Key characteristics



Crushing force  
300 N/cm and more



Tensile force  
up to 4 kN



Operating temperature  
from -40°C to 70°C  
Installation: up to -30°C



Fire-safe



Rodent protection

### Application

The cable is designed for laying in cable channels, pipes, blocks, collectors, tunnels, along bridges and in shafts.

### Technical characteristics

Number of fibers in cable	Nominal calculated cable diameter, mm	Calculated cable weight, kg/km	Tensile force, kN	Min. radius of cable bending, mm
<b>OKKTS(n)-00-1x4...1x48...(2.7)</b>				
Up to 24	8.1	Up to 80	2.7	162
Up to 48	10.7	Up to 117		214

Custom design is available.



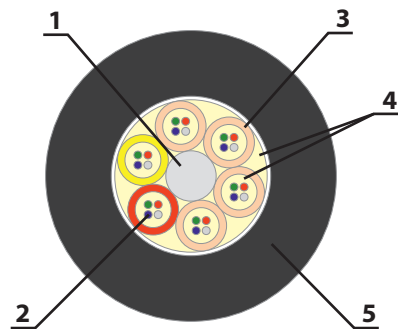
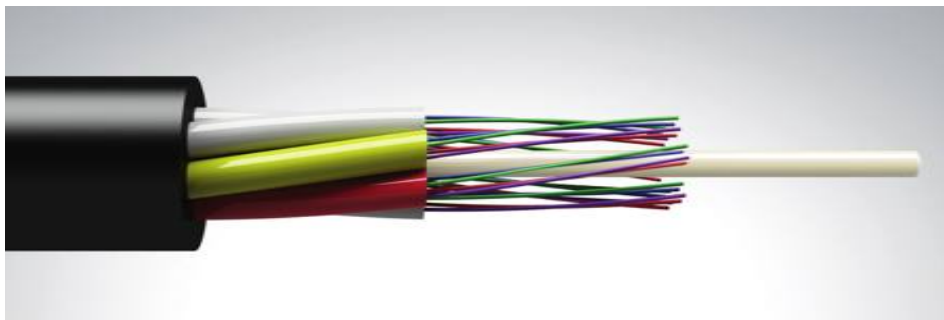

### Key characteristics



Crushing force  
300 N/cm and more



Tensile force is  
up to 3 kN



Operating temperature  
from -40°C to 70°C  
Installation: up to -10°C



Fire-safe



Rodent protection

### Design

1. Central strength member - FRP rod, steel strand or steel wire in PE sheath (or without it).
2. Optical fiber.
3. Tube.
4. Water-blocking material.
5. Outer PE sheath.

### Certificates

- Declaration of conformity for cables type OKTM
- Fire safety certificates for cables type OKTM in categories:
  - n, -ng(A), -ng(A)-HF, -ng(A)-LS, -ng(A)-FR,
  - ng(A)-LTx, -ng(A)-FRHF, -ng(A)-FRLS,
  - ng(A)-HFLTx, -ng(A)-LSLTx, -ng(A)-FRHFLTx,
  - ng(A)-FRLSLTx.

### Application

The cable is designed for installation in cable channels, in plastic tubes. The cable in fire-retardant version is installed indoor.

### Technical characteristics

Number of optical fibers in cable	Number of optical fibers in a tube	Nominal calculated cable diameter, mm	Calculated cable weight, kg/km	Tensile force, kN	Min. radius of cable bending, mm
<b>OKTMn-01-1x4...16x36...-(1.0-2.7)</b>					
Up to 24	Up to 4	10.0	Up to 80	1.0-2.7	200
Up to 48	Up to 8	10.0	Up to 81		200
Up to 72	Up to 12	10.0	Up to 81		200
Up to 96	Up to 12	11.2	Up to 101		224
Up to 144	Up to 12	13.8	Up to 151		276
Up to 288	Up to 24	19.7	Up to 315		394
Up to 72	Up to 36	22.6	Up to 437		452
<b>OKTMn-02-1x4...16x36...-(2.7)</b>					
Up to 24	Up to 4	10.6	Up to 93	2.7	212
Up to 48	Up to 8	10.6	Up to 93		212
Up to 72	Up to 12	10.6	Up to 94		212
Up to 96	Up to 12	11.2	Up to 105		224
Up to 144	Up to 12	13.8	Up to 155		276
Up to 288	Up to 24	19.7	Up to 319		394
Up to 576	Up to 36	22.6	Up to 447		452

Custom design is available.



# OKTTS

## INDOOR OPTICAL CABLES

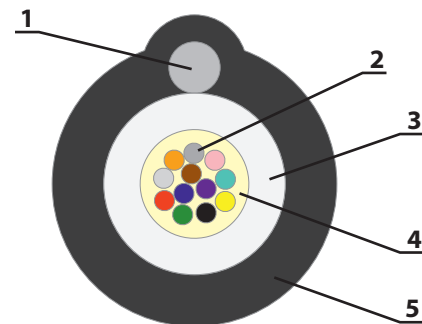

### Key characteristics



Crushing force  
300 N/cm and more



Tensile force is  
up to 3 kN



Operating temperature  
from -40°C to 70°C  
Installation: up to -10°C



Fire-safe



Rodent protection

### Design

1. Strength member – steel galvanized wire.
2. Optical fiber.
3. Central tube.
4. Water-blocking material.
5. Outer fire-retardant PE sheath.

### Certificates

- Declaration of conformity for cables type OKTTS
- Fire safety certificates for cables type OKTTS in categories:
  - n, -ng(A), -ng(A)-HF, -ng(A)-LS, -ng(A)-FR,
  - ng(A)-LTx, -ng(A)-FRHF, -ng(A)-FRLS,
  - ng(A)-HFLTx, -ng(A)-LSLTx, -ng(A)-FRHFLTx,
  - ng(A)-FRLSLTx.

### Application

The cable is designed for installation in cable channels, inside buildings and structures.

### Technical characteristics

Number of fibers in cable	Cable dimensions, mm	Calculated cable weight, kg/km	Tensile force, kN	Min. radius of cable bending, mm
<b>OKTTSng(A)-HF-00-1x4...1x48...-(1.0)</b>				
Up to 24	6.7x7.7	Up to 70	1.0	154
Up to 48	7.8x8.8	Up to 90		176

Custom design is available.

More than **6.500.000 km** of optical fibers have been used in cables manufactured by MKF

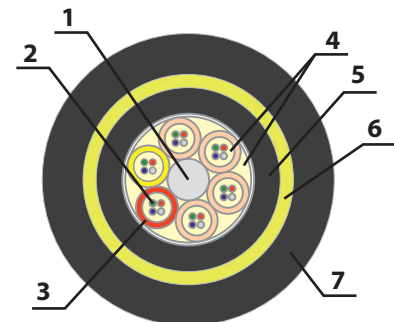
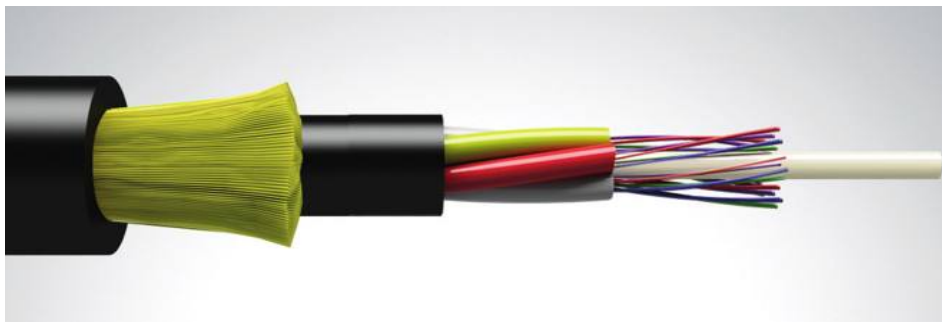

### Key characteristics



Crushing force  
300 N/cm and more



Tensile force is  
up to 50 kN



Operating temperature  
from -60°C to 70°C  
Installation: up to -30°C



For any climatic  
zones



Fire-safe



100% dielectric

### Design

1. Central strength member – FRP rod.
2. Optical fiber.
3. Tube.
4. Water-blocking material.
5. Inner PE sheath (it may be not available on cable with tensile force less than 10 kN).
6. Strength member – aramid filament.
7. Outer PE sheath.

### Certificates

- Declaration of conformity for cables type OKSM
- Fire safety certificates for cables type OKSM in categories: -n, -ng(A), -ng(A)-HF, -ng(A)-LS

### Application

The cable is designed for suspension on overhead supports of communication lines, contact networks of railways and street light poles.

### Technical characteristics

Number of optical fibers in cable	Number of optical fibers in a tube	Nominal calculated cable diameter, mm	Calculated cable weight, kg/km	Tensile force, kN	Min. radius of cable bending, mm
<b>OKSM-01-1x4...12x24...(6.0) without inner sheath</b>					
Up to 24	Up to 4	10.6	Up to 87	6.0	212
Up to 48	Up to 8	11.7	Up to 105		234
Up to 64	Up to 8	13.2	Up to 132		264
Up to 72	Up to 12	12.3	Up to 115		246
Up to 96	Up to 12	13.9	Up to 145		278
Up to 144	Up to 12	17.1	Up to 220		342
<b>OKSM-01-1x4...12x24...(8.0) without inner sheath</b>					
Up to 24	Up to 4	10.8	Up to 90	8.0	216
Up to 48	Up to 8	11.8	Up to 107		236
Up to 64	Up to 8	13.3	Up to 134		266
Up to 72	Up to 12	12.4	Up to 118		248
Up to 96	Up to 12	14.0	Up to 148		280
Up to 144	Up to 12	17.2	Up to 222		344
<b>OKSM-01-1x4...12x24...(10.0) without inner sheath</b>					
Up to 24	Up to 4	11.0	Up to 93	10.0	220
Up to 48	Up to 8	12.0	Up to 110		240
Up to 64	Up to 8	13.5	Up to 137		270
Up to 72	Up to 12	12.5	Up to 120		250
Up to 96	Up to 12	14.1	Up to 150		282
Up to 144	Up to 12	17.3	Up to 224		346

Custom design is available.

# OKSMs

AERIAL OPTICAL CABLE, ALL DIELECTRIC, SELF-SUPPORTING (ADSS)

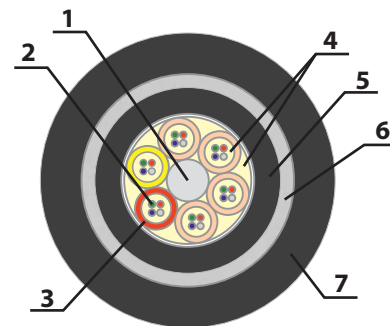
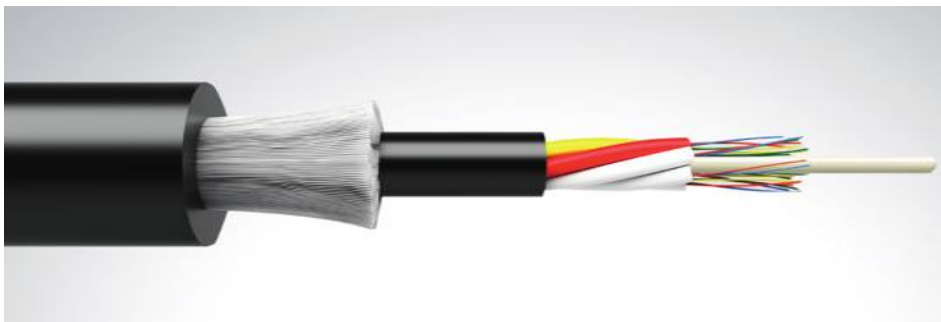

## Key characteristics



Crushing force  
300 N/cm and more



Tensile force is  
up to 15 kN



Operating temperature  
from -60°C to 70°C  
Installation: up to -30°C



For any climatic  
zones



Fire-safe



100% dielectric

## Design

1. Central strength member – FRP rod.
2. Optical fiber.
3. Tube.
4. Water-blocking material.
5. Inner PE sheath (it may be not available on cable with tensile force less than 10 kN).
6. Strength member – glass filament.
7. Outer PE sheath.

## Certificates

- Declaration of conformity for cables type OKSMs
- Fire safety certificates for cables type OKSMs in categories: -n, -ng(A), -ng(A)-HF, -ng(A)-LS

## Application

The cable is designed for suspension on overhead supports of communication lines, contact networks of railways and street light poles.

## Technical characteristics

Number of optical fibers in cable	Number of optical fibers in a tube	Nominal calculated cable diameter, mm	Calculated cable weight, kg/km	Tensile force, kN	Min. radius of cable bending, mm
<b>OKSMs-01-1x4...12x24...(6.0) without inner sheath</b>					
Up to 24	Up to 4	10.7	Up to 94	6.0	214
Up to 48	Up to 8	11.7	Up to 111		234
Up to 64	Up to 8	13.3	Up to 139		266
Up to 72	Up to 12	12.3	Up to 122		246
Up to 96	Up to 12	13.9	Up to 152		278
Up to 144	Up to 12	17.2	Up to 227		344
<b>OKSMs-01-1x4...12x24...(8.0) without inner sheath</b>					
Up to 24	Up to 4	11.0	Up to 102	8.0	220
Up to 48	Up to 8	12.0	Up to 119		240
Up to 64	Up to 8	13.5	Up to 146		270
Up to 72	Up to 12	12.5	Up to 129		250
Up to 96	Up to 12	14.1	Up to 159		282
Up to 144	Up to 12	17.3	Up to 233		346
<b>OKSMs-01-1x4...12x24...(10.0) without inner sheath</b>					
Up to 24	Up to 4	11.2	Up to 108	10.0	224
Up to 48	Up to 8	12.1	Up to 124		242
Up to 64	Up to 8	13.6	Up to 152		272
Up to 72	Up to 12	12.7	Up to 135		254
Up to 96	Up to 12	14.3	Up to 165		286
Up to 144	Up to 12	17.4	Up to 239		348

Custom design is available.

# OKSTS

AERIAL OPTICAL CABLE, ALL DIELECTRIC, SELF-SUPPORTING

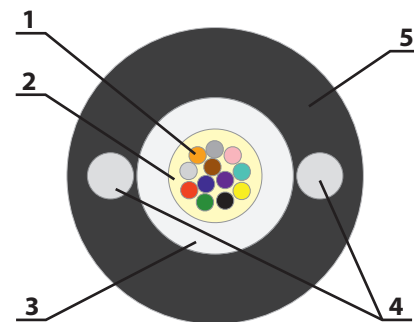
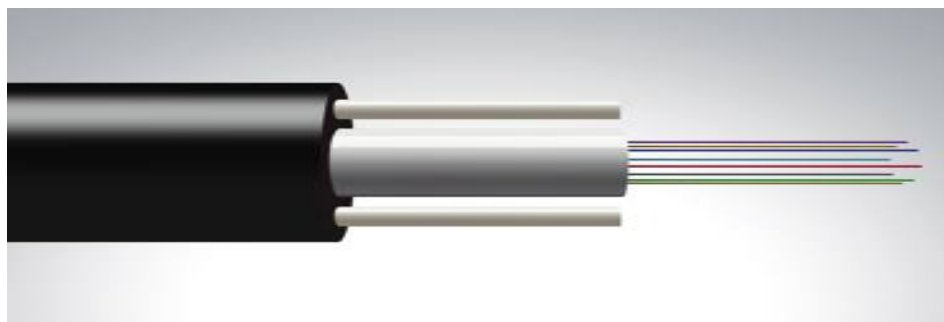

## Key characteristics



Crushing force  
300 N/cm and more



Tensile force is  
up to 15 kN



Operating temperature  
from -60°C to 70°C  
Installation: up to -30°C



For any climatic  
zones



Fire-safe



100% dielectric

## Design

1. Optical fiber.
2. Gel filler.
3. Central tube.
4. Strength member – two FRP rods.
5. Outer PE sheath.

An additional strength member made of aramid or glass filaments is added to cables with allowable tensile force from 3 kN and more.

## Certificates

- Declaration of conformity for cables type OKSTS

## Application

The cable is designed suspension and service on supports of aerial communication lines, street light poles, contact network of town electric transport, supports of radio network.

## Technical characteristics

Number of OF in a cable	Nominal calculated cable diameter, mm	Calculated cable weight, kg/km	Tensile force, kN	Min. radius of cable bending, mm
<b>OKSTS-00-1x4...1x48...(1.5)</b>				
Up to 24	7.0	Up to 43	1.2	140
Up to 48	8.8	Up to 67		176
<b>OKSTS-00-1x4...1x48...(8.0)</b>				
Up to 24	8.2	Up to 65	8.0	164
Up to 48	10.1	Up to 82		202
<b>OKSTS-00-1x4...1x48...(15.0)</b>				
Up to 24	9.4	Up to 80	15.0	188
Up to 48	11.2	Up to 105		224

Custom design is available.



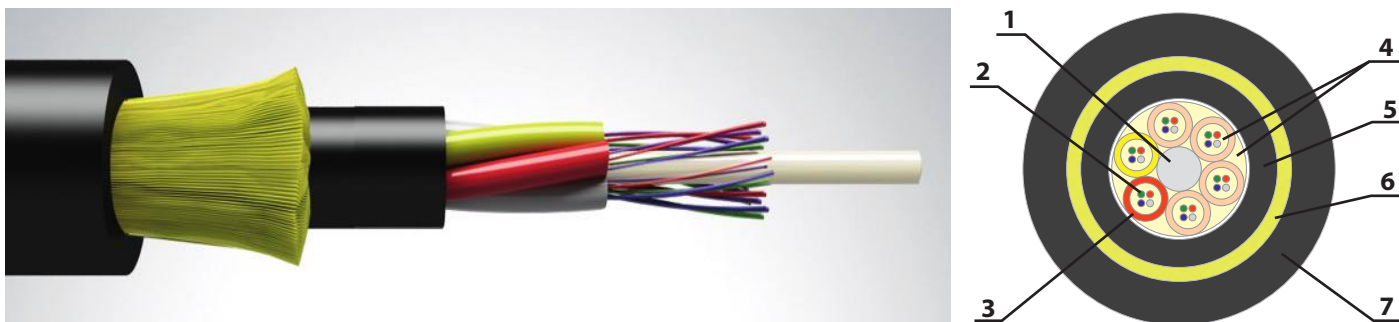

### Key characteristics

 Crushing force 200 N/cm and more	 Tensile force is up to 100 kN	 Operating temperature from -60°C to 70°C Installation: up to -30°C	 For any climatic zones
 Tracking-resistant	 Fire-safe	 100% dielectric	 POCCETI Rosseti certified

### Design

1. Central strength member – FRP rod.
2. Optical fiber.
3. Tube.
4. Water-blocking material.
5. Intermediate PE sheath.
6. Strength member- aramid filament.
7. Outer PE or tracking-resistant PE.

### Certificates

- Declaration of conformity for cables type OKSD
- ROSSETI certified

### Application

The cable is designed for suspension on overhead supports of aerial power lines, and communication lines, contact network of railways.

### Technical characteristics

Number of optical fibers in cable	Number of optical fibers in a tube	Nominal calculated cable diameter, mm	Calculated cable weight, kg/km	Tensile force, kN	Min. radius of cable bending, mm
<b>OKSD-01-1x4...12x24...-(4.0...25.0)-(T)</b>					
Up to 48	Up to 8	15.0	Up to 204	25.0	300
Up to 64	Up to 8	16.4	Up to 240		328
Up to 72	Up to 12	15.6	Up to 219		312
Up to 96	Up to 12	17.1	Up to 219		342
Up to 144	Up to 12	20.1	Up to 350		402
Up to 288	Up to 24	23.0	Up to 452		460
<b>OKCД-01-1x4...12x24...-(25.0...45.0)-(T)</b>					
Up to 48	Up to 8	16.2	Up to 245	45.0	324
Up to 64	Up to 8	17.5	Up to 281		350
Up to 72	Up to 12	16.6	Up to 232		332
Up to 96	Up to 12	18.1	Up to 298		362
Up to 144	Up to 12	20.9	Up to 388		418
Up to 288	Up to 24	23.9	Up to 502		478

Custom design is available.

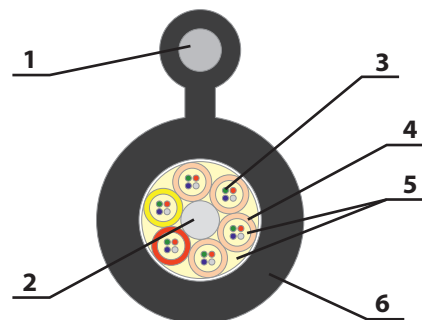
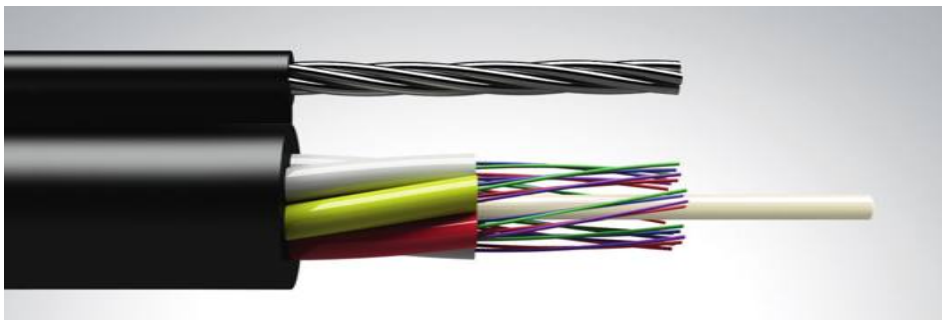

### Key characteristics



Crushing force  
300 N/cm and more



Tensile force is  
up to 15 kN



Operating temperature  
from -60°C to 70°C  
Installation: up to -30°C



For any climatic  
zones

### Design

1. Outer strength member (messenger) - FRP rod, steel strand or steel wire.
2. Central strength member - FRP rod, steel strand or steel wire in PE sheath (or without it).
3. Optical fiber.
4. Tube.
5. Water-blocking material.
6. Outer PE sheath.

### Certificates

- Declaration of conformity for cables type OKPM

### Application

The cable is designed for suspension and service on supports of aerial communication lines, street light poles, contact networks of town electric transport, on supports of radio transmitting network, between buildings and structures.

### Technical characteristics

Number of optical fibers in cable	Number of optical fibers in a tube	Cable dimensions/ Outer strength member diameter, mm	Calculated cable weight, kg/km	Tensile force, kN	Min. radius of cable bending, mm
<b>OKPM-02-1x4...12x24...-(4.0)</b>					
Up to 24	Up to 6	9.5x17.2/4.2	Up to 115	4.0	190
Up to 32	Up to 8	10.3x18.0/4.2	Up to 127		206
Up to 48	Up to 12	10.7x18.4/4.2	Up to 133		214
Up to 72	Up to 12	11.5x19.2/4.2	Up to 152		230
Up to 96	Up to 12	13.2x20.9/4.2	Up to 184		264
Up to 144	Up to 12	16.5x24.2/4.2	Up to 258		330
<b>OKPM-02-1x4...12x24...-(9.0)</b>					
Up to 24	Up to 6	9.5x19.5/6.5	Up to 165	9.0	190
Up to 32	Up to 8	10.3x20.3/6.5	Up to 176		206
Up to 48	Up to 12	10.7x20.7/6.5	Up to 183		214
Up to 72	Up to 12	11.5x21.5/6.5	Up to 202		230
Up to 96	Up to 12	13.2x23.2/6.5	Up to 233		264
Up to 144	Up to 12	16.5x26.5/6.5	Up to 308		330
<b>OKPM-02-1x4...12x24...-(12.0)</b>					
Up to 24	Up to 6	9.5x19.5/6.5	Up to 199	12.0	190
Up to 32	Up to 8	10.3x20.5/6.5	Up to 209		206
Up to 48	Up to 12	10.7x20.7/6.5	Up to 216		214
Up to 72	Up to 12	11.5x21.5/6.5	Up to 234		230
Up to 96	Up to 12	13.2x23.2/6.5	Up to 266		264
Up to 144	Up to 12	16.5x26.5/6.5	Up to 341		330

Custom design is available.

# OKPTS

## SUSPENSION OPTICAL CABLES WITH INTEGRATED MESSENGER

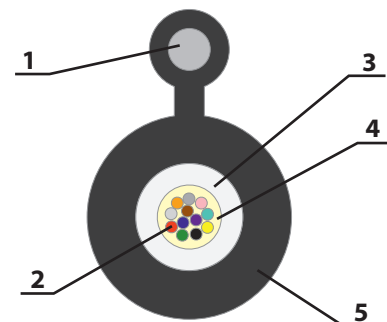

### Key characteristics



Crushing force  
300 N/cm and more



Tensile force is  
up to 12 kN



Operating temperature  
from -60°C to 70°C  
Installation: up to -30°C



For any climatic  
zones

### Design

1. Outer strength member - FRP rod, steel strand or steel wire.
2. Optical fiber.
3. Central tube.
4. Gel filler.
5. Outer PE sheath.

### Certificates

- Declaration of conformity for cables type OKPTS

### Application

The cable is designed for overhead suspension and service on supports of aerial communication lines, street light poles, contact network of town electric transport, supports of radio transmitting network, between buildings and structures.

### Technical characteristics

Number of optical fibers in cable	Cable dimensions/ Outer strength member diameter, mm	Calculated cable weight, kg/km	Tensile force, kN	Min. radius of cable bending, mm
<b>OKPTS-02-1x4...1x48...-(4.0)</b>				
Up to 24	5.7x11.9/4.2	Up to 65	4.0	114
Up to 48	6.8x13.0/4.2	Up to 76		136
<b>OKPTS-02-1x4...1x48...-(6.0)</b>				
Up to 24	5.7x12.5/4.8	Up to 83	6.0	114
Up to 48	6.8x13.6/4.8	Up to 93		136
<b>OKPTS-02-1x4...1x48...-(9.0)</b>				
Up to 24	5.7x13.1/5.4	Up to 105	9.0	114
Up to 48	6.8x14.2/5.4	Up to 115		136

Custom design is available.

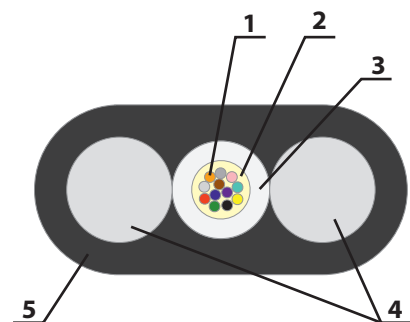
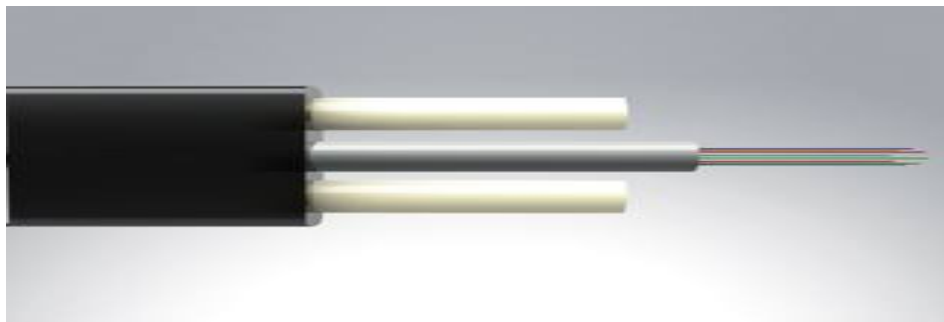

### Key characteristics



Crushing force  
300 N/cm and more



Tensile force is  
up to 7 kN



Operating temperature  
from -60°C to 70°C  
Installation: up to -30°C



For any climatic  
zones



100% dielectric

### Design

1. Optical fiber.
2. Gel filler inside the tube.
3. Central tube.
4. Strength member in the form of FRP rods.
5. Outer PE sheath.

### Certificates

- Declaration of conformity for cables type OKPP

### Application

The cable is designed for overhead suspension and service on supports of aerial communication lines, street light poles, contact networks of town electric transport, overhead supports of radio transmitting network, between buildings and structures. It can be installed inside buildings, in cable channels, along buildings fronts.

### Technical characteristics

Number of OF in a cable	Cable dimensions, mm	Calculated cable weight, kg/km	Tensile force, kN	Min. radius of cable bending, mm
<b>OKPP-01-1x4...1x24...-(1.2)</b>				
4	3.4x6.8	Up to 28.2	1.2	68
8	3.4x6.8	Up to 28.2		68
12	3.7x7.8	Up to 34.6		74
16	4.0x8.4	Up to 42.0		80
24	4.2x9.4	Up to 47.4		86

Custom design is available.





COMBINED OPTICAL  
COMMUNICATION  
CABLES

## LABELING OF COMBINED OPTICAL CABLES

### Combined optical cables

**KSPP OKGM** are designed for direct bury, for cable channels, pipes, blocks, collectors, tunnels and shafts, when crossing swamps and non-navigable rivers.

**KSPP OKKM** are designed for laying in cable channels, pipes, blocks, collectors, in tunnels, along bridges and in shafts.

communication lines, contact networks of railways, and street light poles.

**KSPP OKPM** are designed for suspension on overhead communication lines, street poles, between buildings and structures.

### Combined optical cables for laying by means of pneumatic blowing and indoor installation.

**KSPP OKTM** are designed for laying in plastic pipes.

### Aerial combined optical cables

**SIP-3/OM, SIP-3/OTS** are designed for suspension on overhead

STRUCTURE OF LABELING OF COMBINED CABLES (OPTICAL FIBERS AND COPPER CONDUCTORS)								
KSPP	OC	G	M	ng(A)	-4Mx0,9/	-01	-3x4E3/...*	-(7,0)
								Allowable tensile force (static), kN
								Number of tubes x number of OF in a tube:
								Type of OF:
								E3 – single-mode OF with low water peak according to ITU-TG.652.D with a reduced radius of bending according to ITU-TG.657.A1; or single-mode OF with low water peak according to ITU-TG.652.D
								E5 – single-mode OF with non-zero dispersion according to ITU-T G.655
								M1 (OM2) – multimode OF 50/125 according to ITU-T G.651.1
								M2 (OM1) - multimode 62.5/125 according to IEC 60793-2-10
								M3 (OM3)- multimode 50/125 according to ITU-T G.651.1
								M4 (OM4) - multimode 50/125 according to ITU-T G.651.1
								Design:
								01 – multitube, central strength member (or outer member for KSPP OKPM)
								02 – multitube, central strength member (outer member, for KSPP OKPM), steel strand
								03 – multitube, central strength member (outer member for KSPP OKPM), steel wire
								04 – multitube, outer strength member, for OKPM and OKPTS – aramid filament
								Number of copper conductors x rated diameter of a copper conductor
								Fire-retardant PE sheath:
								n – in individual laying;
								ng(A) – in bundle laying;
								ng(A)-LS – in bundle laying with lower smoke and gas liberation;
								ng(A)-HF – in bundle laying without liberation of corrosive gaseous products when burning or smoldering (halogen-free)
								Type of design:
								M – loose tube design
								Type of laying
								G – optical cable for direct bury
								K – optical cable for laying in channels
								P – suspension optical cable
								T – optical cable for laying in pipes
								Optical cable
								K – cable, S – local network, P – polyethylene sheath, P – protective PE sheath

STRUCTURE OF LABELING OF COMBINED SELF-SUPPORTING WIRE WITH OPTICAL FIBERS						
SIP	-3	1x70	-20/	O	M	-16E3*
						Number of OF
						Type of OF:
						E3 – single-mode OF with low water peak according to ITU-TG.652.D with reduced radius of bending according to ITU-TG.657.A1 («Ace»); or single-mode OF with low peak water according to ITU-TG.652.D
						E5 – single-mode OF with non-zero shifted dispersion according to ITU-T G.655
						M1 (OM2) – multimode OF 50/125 according to ITU-T G.651.1
						M2 (OM1) – multimode OF 62.5/125 according to IEC60793-2-10
						M3 (OM3)- multimode OF 50/125 according to ITU-T G.651.1
						M4 (OM4) – multimode OF 50/125 according to ITU-T G.651.1
						Type of design:
						M – loose tube design
						TS – design with a central tube
						Optical part
						Rated voltage (kV)
						Number of conductors x rated cross-section of conductor (mm <sup>2</sup> )
						Type of wire design
						Self-supporting insulated wire

### Footnotes:

\* - if various types of optical fibers (E3...M1) are used, number of tubes and optical fibers in a tube of each type are shown separately.

**Abbreviations:** PE – polyethylene, OF – optical fiber, FRP – fiber-reinforced polyethylene.

# KSPP OKGM

COMBINED OPTICAL CABLES WITH COPPER CONDUCTORS FOR DIRECT BURY

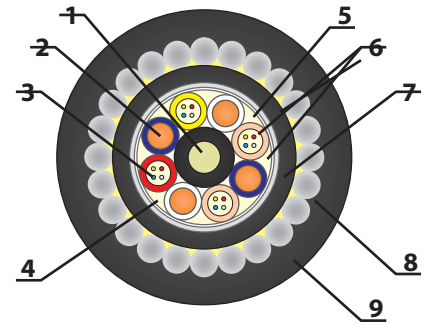
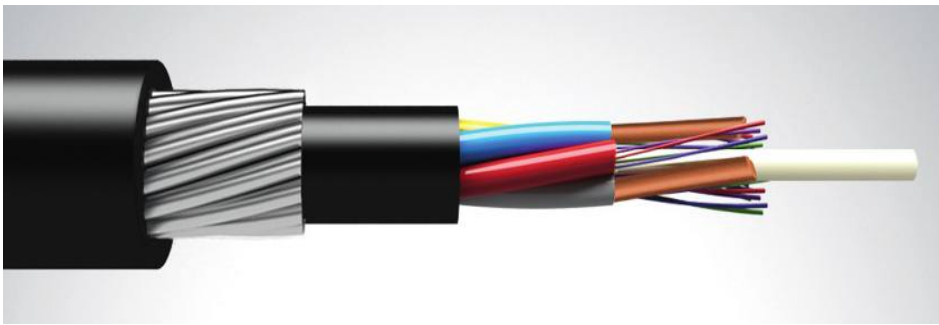

## Key characteristics



Crushing force  
from 400 N/cm



Tensile force  
up to 80 kN



Operating temperature  
from -40°C to 70°C  
Arctic version from -60°C to 70°C  
Installation: up to -30°C



For any climatic  
zones



Fire-safe



Rodent protection

## Design

1. Central strength member - FRP rod in PE sheath.
2. Insulated copper conductor.
3. Optical fiber.
4. Tube.
5. Laminated aluminum PE tape.
6. Water-blocking material.
7. Intermediate PE sheath.
8. Round steel wire.
9. Outer PE sheath.

## Application

The cable is designed for direct bury, in cable channels, pipes, blocks, collectors, tunnels, in shafts, in water when crossing swamps, lakes, and rivers.

## Technical characteristics

Number of optical fibers in cable	Number of optical fibers in a tube	Nominal calculated cable diameter, mm	Calculated cable weight, kg/km	Tensile force, kN	Min. radius of cable bending, mm
-----------------------------------	------------------------------------	---------------------------------------	--------------------------------	-------------------	----------------------------------

### KSPP OKGM(n)-4Mx0.9/01-1x4...4x24...-(7.0)

Up to 48	Up to 12	15.6	Up to 459	7.0	312
Up to 96	Up to 24	20.3	Up to 682		406

### KSPP OKGM(n)-4Mx1.2/01-1x4...4x24...-(7.0)

Up to 48	Up to 12	18.1	Up to 603	7.0	362
Up to 96	Up to 24	20.3	Up to 693		406

Custom design is available.

# KSPP OKKM

COMBINED OPTICAL CABLES WITH COPPER CONDUCTORS FOR LAYING IN CABLE CHANNELS

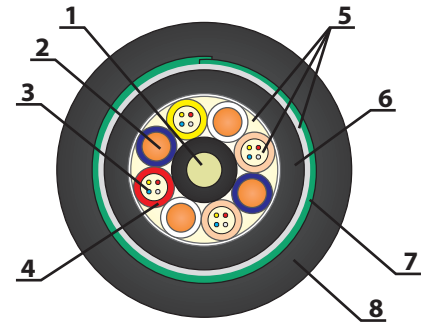
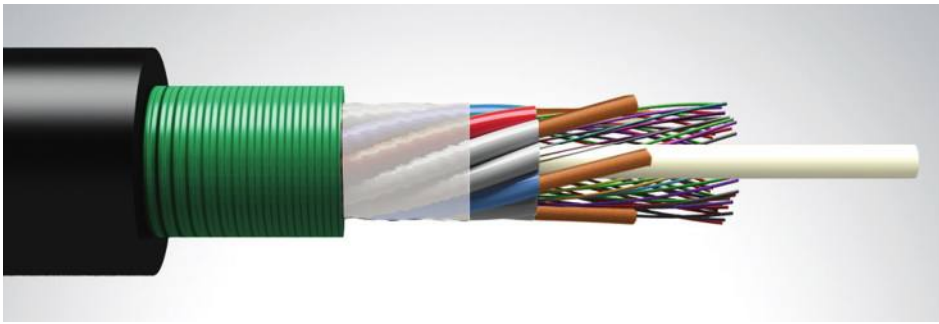

## Key characteristics



Crushing force  
300 N/cm and more



Tensile force  
up to 4 kN



Operating temperature  
from -60°C to 70°C  
Installation: up to -10°C



Fire-safe



Rodent protection

## Design

1. Central strength member - FRP rod in PE sheath.
2. Insulated copper core.
3. Optical fiber.
4. Tube.
5. Water-blocking material.
6. Intermediate PE sheath.
7. Steel corrugated tape.
8. Outer PE sheath.

## Application

The cable is designed for laying in cable channels, pipes, blocks, collectors, tunnels, along bridges, and in shafts.

## Technical characteristics

Number of optical fibers in cable	Number of optical fibers in a tube	Nominal calculated cable diameter, mm	Calculated cable weight, kg/km	Tensile force, kN	Min. radius of cable bending, mm
-----------------------------------	------------------------------------	---------------------------------------	--------------------------------	-------------------	----------------------------------

### KSPP OKKM(n)-4Mx0.9/01-1x4...4x24...-(2.7)

Up to 48	Up to 12	14.4	Up to 220	2.7	288
Up to 96	Up to 24	18.1	Up to 306		362

### KSPP OKKM(n)-4Mx1.2/01-1x4...4x24...-(2.7)

Up to 48	Up to 12	15.9	Up to 270	2.7	318
Up to 96	Up to 24	18.1	Up to 335		362

Custom design is available.



# KSPP OKTM

COMBINED OPTICAL CABLES WITH COPPER CONDUCTORS FOR LAYING IN PLASTIC PIPES BY PNEUMATIC BLOWING

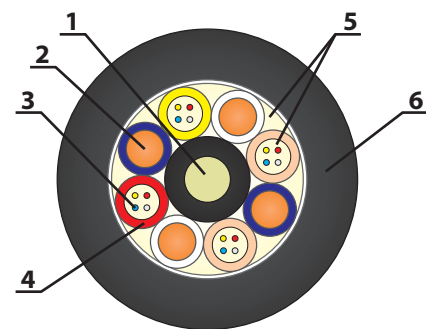
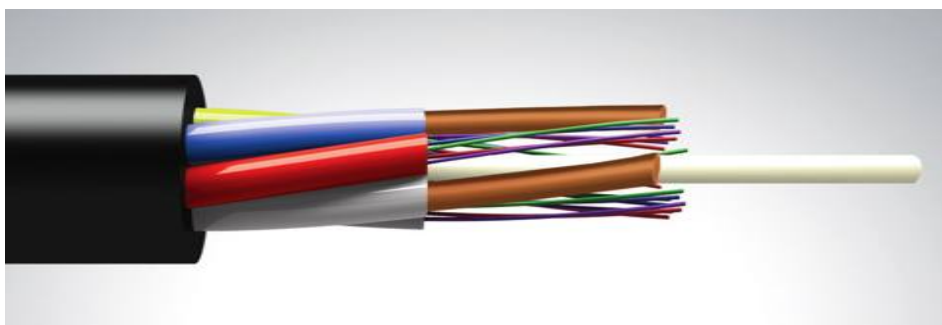

## Key characteristics



Crushing force  
300 N/cm and more



Tensile force  
up to 3 kN



Operating temperature  
from -40°C to 70°C  
Installation: up to -10°C



Fire-safe



Rodent protection

## Design

1. Central strength member.
2. Insulated copper electrical conductor.
3. Optical fiber.
4. Tube.
5. Water-blocking material.
6. Outer PE sheath.

## Application

The cable is designed for laying in cable channels, pipes, blocks, collectors, tunnels, along bridges, and in shafts. In fire-resistant version could be installed indoor.

## Technical characteristics

Number of optical fibers in cable	Number of optical fibers in a tube	Nominal calculated cable diameter, mm	Calculated cable weight, kg/km	Tensile force, kN	Min. radius of cable bending, mm
-----------------------------------	------------------------------------	---------------------------------------	--------------------------------	-------------------	----------------------------------

### KSPP OKTM(n)-4Mx0.9/01-1x4...4x24...-(2.7)

Up to 48	Up to 12	11.2	Up to 120	1.0 – 2.7	224
Up to 96	Up to 24	14.9	Up to 188		298

### KSPP OKTM(n)-4Mx1.2/01-1x4...4x24...-(2.7)

Up to 48	Up to 12	12.7	Up to 160	1.0 – 2.7	254
Up to 96	Up to 24	14.9	Up to 204		298

Custom design is available.

# KSPP OKPM

COMBINED OPTICAL CABLES WITH COPPER CONDUCTORS, WITH INTEGRATED MESSENGER

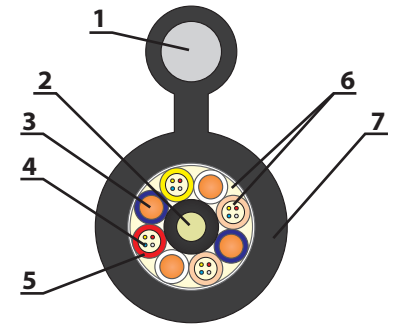
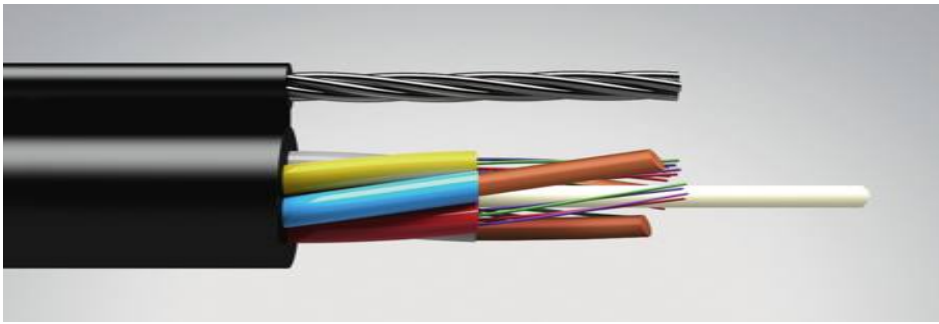

## Key characteristics



Crushing force  
300 N/cm and more



Tensile force is  
up to 15 kN



Operating temperature  
from -60°C to 70°C  
Installation: up to -30°C



For any climatic  
zones

## Design

1. Steel messenger.
2. Central strength member.
3. Insulated copper conductor.
4. Optical fiber.
5. Tube.
6. Water-blocking material.
7. Outer PE sheath.

## Application

The cable is designed for overhead suspension and for service on supports of aerial communication lines, street light poles, contact networks of town transport, overhead supports of radio transmission lines, between buildings and structures.

## Technical characteristics

Number of optical fibers in cable	Number of optical fibers in a tube	Cable dimensions/ Outer strength member diameter, mm	Calculated cable weight, kg/km	Tensile force, kN	Min. radius of cable bending, mm
<b>KSPP OKPM-4Mx0.9/-02-1x4...4x24...-(4.0)</b>					
Up to 48	Up to 12	12.7x20.7/4.2	Up to 181	4,0	254
Up to 96	Up to 24	14.9x21.0/4.2	Up to 222		298
<b>KSPP OKPM-4Mx1.2/-02-1x4...4x24...-(4.0)</b>					
Up to 48	Up to 12	12.7x20.7/4.2	Up to 193	4,0	254
Up to 96	Up to 24	14.9x21.0/4.2	Up to 235		298
<b>KSPP OKPM-4Mx0.9/-02-1x4...4x24...-(9.0)</b>					
Up to 48	Up to 12	12.7x22.7/6.5	Up to 230	9,0	254
Up to 96	Up to 24	14.9x24.9/6.5	Up to 270		298
<b>KSPP OKPM-4Mx1.2/-02-1x4...4x24...-(9.0)</b>					
Up to 48	Up to 12	12.7x22.7/6.5	Up to 241	9,0	254
Up to 96	Up to 24	14.9x24.9/6.5	Up to 282		298
<b>KSPP OKPM-4Mx0.9/-02-1x4...4x24...-(12.0)</b>					
Up to 48	Up to 12	12.7x22.7/6.5	Up to 260	12,0	254
Up to 96	Up to 24	14.9x24.9/6.5	Up to 300		298
<b>KSPP OKPM-4Mx1.2/-02-1x4...4x24...-(12.0)</b>					
Up to 48	Up to 12	12.7x22.7/6.5	Up to 271	12,0	254
Up to 96	Up to 24	14.9x24.9/6.5	Up to 312		298

Custom design is available.

# SIP-3/OM, SIP-3/OTS

COMBINED OPTICAL CABLES WITH ALUMINUM CONDUCTOR, SELF-SUPPORTING, PROTECTED

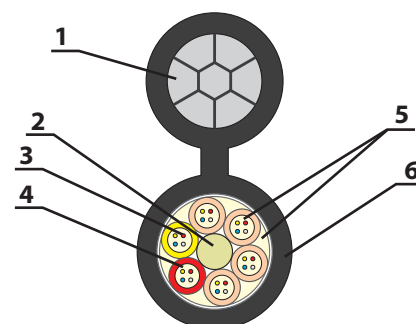
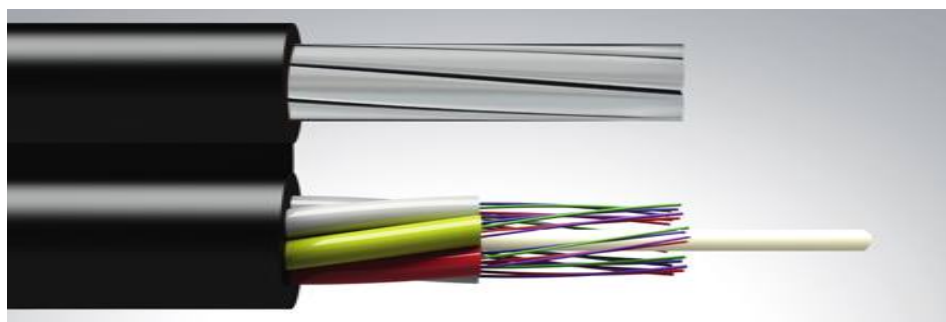

## Key characteristics



Crushing force  
300 N/cm and more



Tensile force is  
up to 50 kN



Operating temperature  
from -60°C to 70°C  
Installation: up to -30°C



For any climatic  
zones

## Design

1. Outer messenger (electrical conductor of aluminum alloy SIP-3)
2. Central strength member made of FRP.
3. Optical fiber.
4. Loose tube.
5. Water blocking element.
6. Outer light-stabilized XPE sheath.

Cable with a central tube with up to 48 optical fibers is available.

## Application

The cable is designed for suspension and service on aerial lines supports for rated voltage 20 and 35 kV, in atmosphere of type I, II and III, with climatic solutions B according to GOST 15150-69, including the atmosphere overseas, salty lakes, in industrial regions and of saline sands.

## Certificates

- Declaration of conformity for cables type SIP-3/OM/OTS
- Certificate of conformity for cables type SIP-3/OM/OTS

## Technical characteristics

Number of optical fibers in cable	Number of optical fibers in a tube	Cable dimensions/ Outer strength member diameter, mm	Calculated cable weight, kg/km	Tensile force, kN	Min. radius of cable bending, mm
<b>SIP-3 1x70-20/OM -144...</b>					
Up to 48	Up to 12	12.3x30.1/14.3	Up to 411	20,6	286
Up to 96	Up to 12	14.8x32.6/14.3	Up to 463		296
Up to 144	Up to 12	18.1x35.9/14.3	Up to 543		362
<b>SIP-3 1x70-35/OM -144...</b>					
Up to 48	Up to 12	14.7x34.9/16.7	Up to 520	20,6	334
Up to 96	Up to 12	17.2x37.4/16.7	Up to 581		344
Up to 144	Up to 12	20.5x40.7/16.7	Up to 673		410
<b>SIP-3 1x70-20/OTS -48...</b>					
Up to 24	Up to 24	8.9x26.7/14.3	Up to 418	20,6	286
Up to 48	Up to 48	10.0x27.8/14.3	Up to 455		286
<b>SIP-3 1x70-35/OTS -48...</b>					
Up to 24	Up to 24	11.3x31.5/16.7	Up to 502	20,6	334
Up to 48	Up to 48	12.4x32.6/16.7	Up to 555		334

Custom design is available.



OPTICAL CABLES FOR LANs



## LABELING OF OPTICAL CABLES FOR LANs

### Overhead suspension optical cables

**OKDP with an outer strength member** is designed for suspension on supports of aerial communication lines, street poles, contact networks of electric city transport, radio transmission networks, for indoor installation inside buildings and structures.

### Service optical cables

**OKS** is designed for installation in special cable basements, boxes, inside buildings and structures.

**OKD** is designed for installation in special cable ducts, boxes, outside and inside buildings and structures.

**OKDP** is designed for installation in special cable ducts, boxes, outside and inside buildings and structures.

### Distribution optical cables

**OKR** is designed for installation in special cable ducts, boxes, outside and inside buildings and structures, including vertical installation.

**OKV** is designed for indoor applications; it is installed vertically in risers of buildings and structures.

STRUCTURE OF LABELING OF OPTICAL CABLES FOR LANs						
OC	V	ng(A)	-02-	-1x4	G.657.A1	- B0,9 - -(1,0)
						<b>Allowable tensile force (static), kN</b>
						<b>Special features of design (this column is not available in cable marking of OKDP):</b>
						B – OF in tight buffer, the figure after the latter designate the outer diameter of one fiber in in tight buffer.
						M – microtubes are used in the cable, the figure after the letter designates the diameter of one microtube.
						3.0/0.9 – diameter of Simplex or dimensions of Duplex, height/diameter of optical fiber in tight buffer.
						<b>Type of optical fiber:</b>
						G.652.D – single-mode OF with low-water peak according to ITU-TG.652.D
						G.655 – single-mode OF with non-zero shifted dispersion according to ITU-T G.655
						G.657.A1 - single-mode OF with reduced radius of bending according to ITU-T G.657.A1
						G.657.A2 - single-mode OF with reduced radius of bending according to ITU-T G.657.A2
						OM1 – multimode OF 62.5/125 according to IEC60793-2-10
						OM2 – multimode OF 50/125 according to ITU-T G.651.1
						OM3 – multimode OF 50/125 according to ITU-T G.651.1
						OM4 - multimode OF 50/125 according to ITU-T G.651.1
						<b>Number of optical fibers or number of microtubes x number of OF in a micromodule. In designs with one bunch of fibers (without microtubes) the first figure in this column is not available.</b>
						<b>Engineering design (ONLY IN LABELING OF CABLES OKPD):</b>
						00- strength members: 2 FRP rods
						01- strength members: 2 steel wires
						02 –outer strength member: steel wire and strength elements: 2 FRP rods
						03 - outer strength member: steel wire and strength elements: 2 steel wires
						04 - outer strength member: one FRP rod and strength elements: 2 FRP rods
						05 - outer strength member: one FRP rod and strength elements: 2 steel wires
						<b>Sheath made of fire-retardant PE:</b>
						ng(A) – in bundle laying
						ng(A)-LS – in bundle laying, with lower smoke and gas liberation
						ng(A)-HF – in bundle laying (halogen-free)
						<b>Type of design or employment:</b>
						V – optical cable for vertical installation (type «Riser»)
						D – subscriber’s optical cable (type «Duplex»)
						DP – optical cable, drop flat and drop flat with an outer strength member
						R – distribution optical cable (type «Distribution»)
						S – subscriber’s optical cable (type «Simplex»)
						T – optical fiber in tight buffer
<b>Optical cable</b>						

**Abbreviations:** PE – polyethylene, OF – optical fiber, FRP – fiber-reinforced plastic.

# OKR (Distribution)

## DISTRIBUTION OPTICAL CABLES

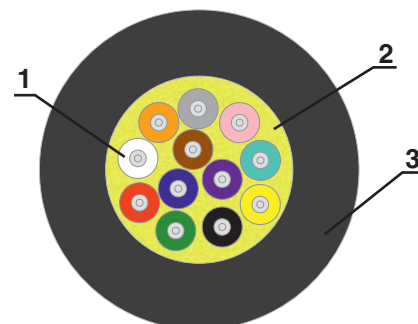
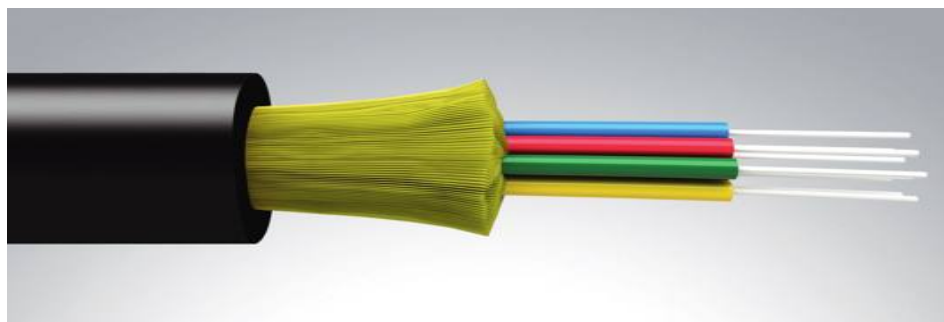

### Key characteristics



Crushing force  
30 N/cm and more



Tensile force is  
up to 0.5 kN



Operating temperature  
from -40°C to 50°C  
Installation: up to -10°C



Fire-safe



Bending resistance

### Design

1. Optical fiber in tight-buffer.
2. High-modulus filament.
3. Outer PE or PVC fire-retardant sheath.

As a strength member here could be used FRP rod or steel wire.

### Certificates

- Declaration of conformity for cables type OKR
- Fire safety certificates for cables type OKR in categories:  
-n, -ng(A), -ng(A)-HF, -ng(A)-LS.

### Application

The cable is designed for indoor and outdoor installation; it is laid in special cable ducts, boxes, outside and inside of buildings and structures, including vertical installation.

### Technical characteristics

Number of fibers in the cable	Nominal calculated cable diameter, mm	Calculated cable weight, kg/km	Tensile force, kN	Min. radius of cable bending, mm
<b>OKR-ng(A)-HF-2...24G.652.DxB0.9-(0.5)</b>				
2	5.0	Up to 28	0.5	50
4	5.6	Up to 34		56
8	7.2	Up to 49		72
12	7.2	Up to 53		72

# OKR (Distribution) with microtubes

## DISTRIBUTION OPTICAL CABLES

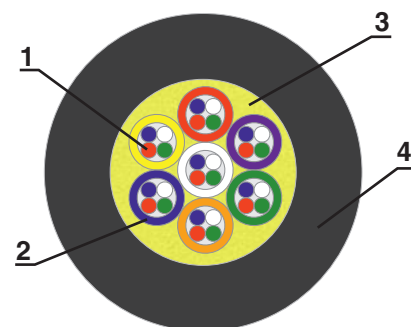
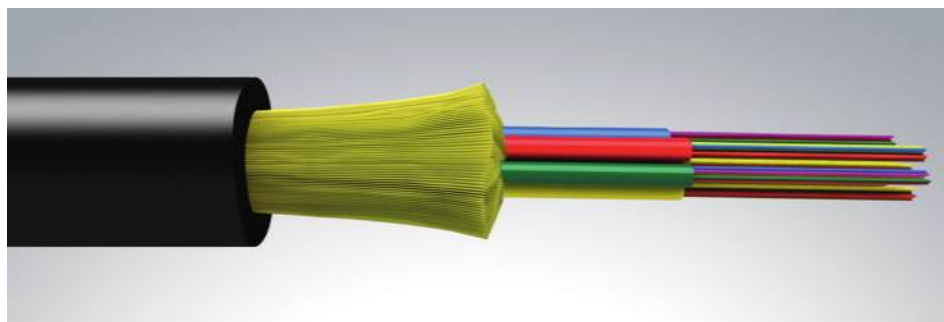

### Key characteristics



Crushing force  
30 N/cm and more



Tensile force is  
up to 0.5 kN



Operational temperature  
from -10 °C up to 50°C.  
Installation: up to -10°C



Fire-safe



Bending resistance

### Application

The cable is designed for indoor and outdoor installation; it is laid in special cable ducts, boxes, outside and inside buildings and structures, including vertical installation.

### Design

1. Optical fiber.
2. Microtube
3. High-modulus filament.
4. Outer PE or PVC fire-retardant sheath.

As a strength member here could be used FRP rod or steel wire.

### Certificates

- Declaration of conformity for cables type OKR
- Fire safety certificates for cables type OKR in categories:  
-n, -ng(A), -ng(A)-HF, -ng(A)-LS.

### Technical characteristics

Number of OF in a cable	Nominal calculated cable diameter, mm	Calculated cable weight, kg/km	Tensile force, kN	Min. radius of cable bending, mm
<b>OKR-ng(A)-HF-1x4...24x12...xM...-(0.5)</b>				
24	5.9	31	0.5	59
36	6.6	36		66
48	7.2	42		72
64	8.0	51		80
96	9.1	61		91
144	10.7	79		107

# OKV (Riser)

## DISTRIBUTION OPTICAL CABLES

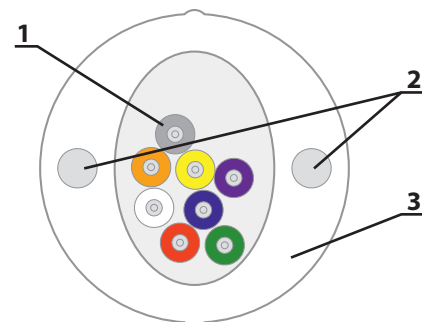
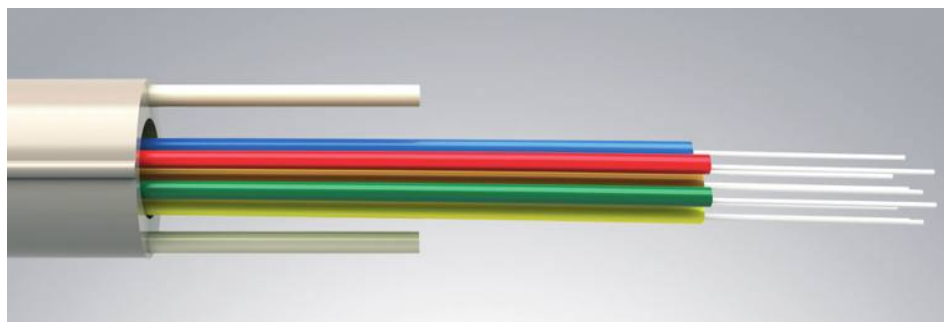

### Key characteristics



Crushing force  
200 N/cm and more



Tensile force is  
up to 1.0 kN



Operational temperature  
from -10°C to 50°C.  
Installation: up to -10°C



Fire-safe



Bending resistance

### Design

1. Optical fiber in tight-buffer.
2. FRP rods.
3. Outer PE or PVC fire-retardant sheath.

### Certificates

- Declaration of conformity for cables type OKV
- Fire safety certificates for cables type OKV in categories:  
-n, -ng(A), -ng(A)-HF, -ng(A)-LS.

### Application

The cable is designed for indoor applications and laid in vertical risers of building and structures.

### Technical characteristics

Number of OF in a cable	Nominal calculated cable diameter, mm	Calculated cable weight, kg/km	Tensile force, kN	Min. radius of cable bending, mm
<b>OKV-ng(A)-HF-2...48G.657.A1XB0.9-(1.0)</b>				
8	8.5	63.8	1.0	85
12	8.5	64.8		85
24	10.5	91.1		105



# OKV (Riser) with microtubes

## DISTRIBUTION OPTICAL CABLES

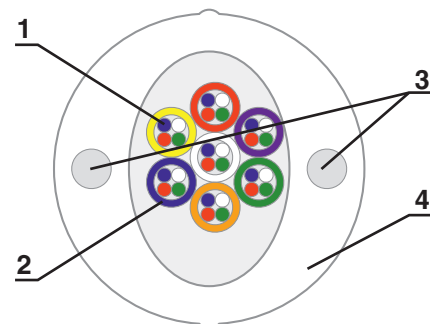
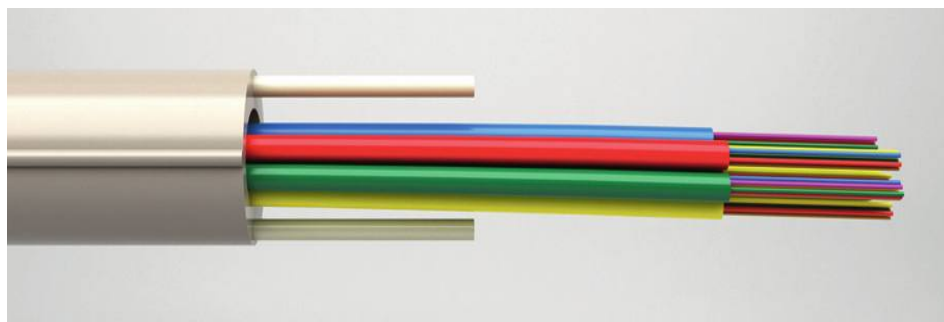

### Key characteristics



Crushing force  
200 N/cm and more



Tensile force is  
up to 1.0 kN



Operational temperature  
from -10°C to 50°C.  
Installation: up to -10°C



Fire-safe



Bending resistance

### Design

1. Optical fiber.
2. Microtubes.
3. FRP rods.
4. Outer PE or PVC fire-retardant sheath.

### Certificates

- Declaration of conformity for cables type OKV
- Fire safety certificates for cables type OKV in categories:  
-n, -ng(A), -ng(A)-HF, -ng(A)-LS.

### Application

The cable is designed for indoor arrangement and laid in vertical risers of buildings and structures.

### Technical characteristics

Number of OF in a cable	Number of OF in a micromodule	Nominal calculated cable diameter, mm	Calculated cable weight, kg/km	Tensile force, kN	Min. radius of cable bending, mm
-------------------------	-------------------------------	---------------------------------------	--------------------------------	-------------------	----------------------------------

#### OKV-ng(A)-HF-1x4...12x12G.657.A1xM...-(1.0)

48	4	10.5	80.0	1,0	105
	6				105
96	4	13.5	137.0		135
	6		137.5		135
144	4	13.5	145.0		135
	6		145.5		135
288	12	14.5	167.7	145	

# OKDP (Drop)

SUBSCRIBER'S OPTICAL CABLES

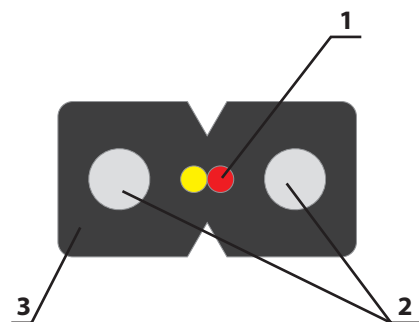
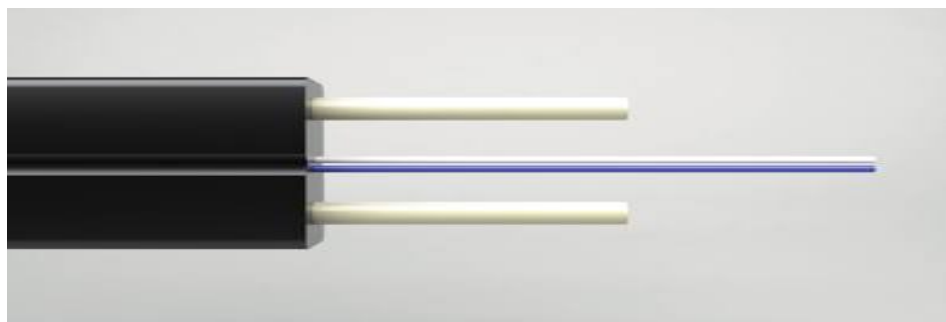

## Key characteristics



Crushing force  
300 N/cm and more



Tensile force is  
up to 0.22 kN



Operating temperature  
from -60°C to 70°C.  
Installation: up to -30°C



Fire-safe



Bending resistance

## Design

1. Optical fiber.
2. Strength member - steel galvanized wire or a FRP rod.
3. Outer HF-LS sheath.

## Certificates

- Declaration of conformity for cables type OKDP
- Fire safety certificates for cables type OKDP in categories:  
-n, -ng(A), -ng(A)-HF, -ng(A)-LS.

## Application

The cable for suspension and for laying in special cable ducts, boxes, outside and inside buildings and structures.

## Technical characteristics

Number of fibers in a cable	Cable dimensions, mm	Calculated cable weight, kg/km	Tensile force, kN	Min. radius of cable bending, mm
-----------------------------	----------------------	--------------------------------	-------------------	----------------------------------

### OKDP-ng(A)-HF-00-1..4G.657.A1-(0.22)

1	2.0x3.0	8.9	0.22	60
2	2.0x3.0	9.0		60
4	2.0x3.0	9.1		60

# OKDP (Drop) with messenger

DISTRIBUTION OPTICAL CABLES WITH INTEGRATED STRENGTH MESSENGER

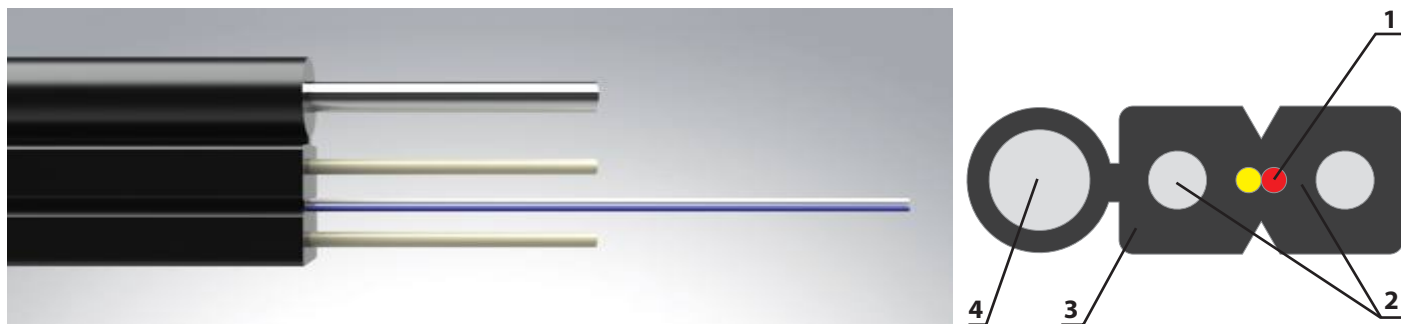

## Key characteristics



Crushing force  
300 N/cm and more



Tensile force is  
up to 1.0 kN



Operating temperature  
from -60°C to 70°C.  
Installation: up to -30°C



Fire-safe



Bending presistance

## Design

1. Optical fiber.
2. Outer HF-LS sheath.
3. Outer messenger– steel galvanized wire or FRP rod.
4. Strength member – steel galvanized wire or a GFP.

## Certificates

- Declaration of conformity for cables type OKDP
- Fire safety certificates for cables type OKDP in categories:  
-n, -ng(A), -ng(A)-HF, -ng(A)-LS

## Application

The cable is designed for suspension on the supports of overhead communication lines, street light poles, contact networks of town transport, radio transmission supports, for indoor applications.

## Technical characteristics

Number of fibers in a cable	Cable dimensions, mm	Calculated cable weight, kg/km	Tensile force, kN	Min. radius of cable bending, mm
<b>OKDP-ng(A)-HF-02-1..4G.657.A1-(1.0)</b>				
1	2.0x5.0	19.0	1.0	100
2	2.0x5.0	19.1		100
4	2.0x5.0	19.3		100

# OKS (Simplex) OKD (Duplex)

SUBSCRIBER'S INDOOR OPTICAL CABLES

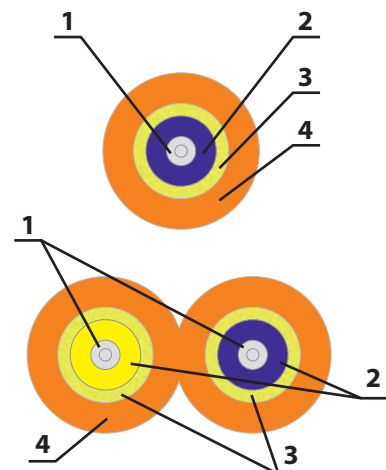
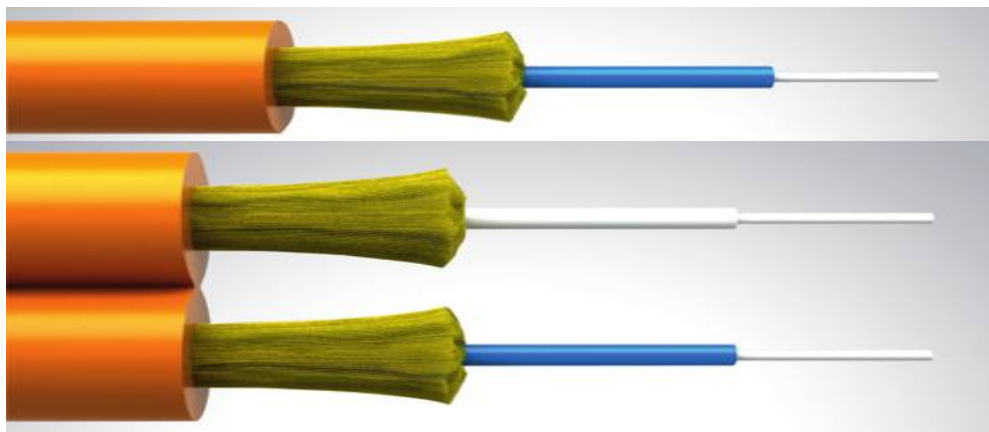

## Key characteristics



Crushing force  
300 N/cm and more



Tensile force is  
up to 1.0 kN



Operating temperature  
from -60°C to 70°C.  
Installation: up to -30°C



Fire-safe



Bending presistance

## Application

The cable is designed for indoor applications, manufacturing of optical cords and pigtails. It is installed in special cable ducts, boxes, inside buildings and structures.

## Design

1. Optical fiber.
2. Buffer layer of polyamid, PE, PVC, or other materials.
3. High-modulus filament.
4. Outer fire-retardant PE or PVC sheath.

## Certificates

- Declaration of conformity for cables type OKS
- Declaration of conformity for cables type OKD
- Fire safety certificates for cables type OKS, OKD in categories:  
-n, -ng(A), -ng(A)-HF, -ng(A)-LS.

## Technical characteristics

Number of fibers in a cable	Cable dimensions, mm	Calculated cable weight, kg/km	Tensile force, kN	Min. radius of cable bending, mm
<b>OKS-ng(A)-G.657.A1x1.8/0.9-(0.1)</b>				
1	1.8	3.6	0.1	According to specification for OF
<b>OKS-ng(A)-G.657.A1x2.8/0.9-(0.1)</b>				
1	2.8	8.0	0.1	According to specification for OF
<b>OKD-ng(A)-G.657.A1x1.8/0.9-(0.1)</b>				
2	1.8x3.6	7.2	0.1	According to specification for OF
<b>OKD-ng(A)-G.657.A1x2.8/0.9-(0.1)</b>				
2	2.8x5.6	16.0	0.1	According to specification for OF







EQUIPMENT  
FOR INSTALLATION  
OF FIBER-OPTICAL CABLES

## EQUIPMENT FOR INSTALLATION OF AERIAL OPTICAL CABLES

Appearance	Designations	Max. outer diameter of supporting wire, mm	Max. breaking load, kN	The length of strand from the clamp to the fastener, mm	Material		Weight, kg
					Body	Wedges	

### Anchor terminal clamps for 8-shaped cables, with an outer strength member made of strand, FRP, or wire

	RA 06 200	Up to 6	2.3	200	UV-resistant polymer		0.12
	RA 06 200M	Up to 6	3	200	Zink alloy		0.095
	RA 35 200	3-5	3.5	200-300	UV-resistant polymer	UV-resistant polymer	0.14
	RA 37 200	3-7	3.5	200			0.14
	RA 610 CM	6-10	7	300	High-stress aluminum alloy		0.7
	RA 07 250	Up to 7	7.3	250-300			0.27
	RA 07 250M	Up to 7	5.0	250			0.135
	RA 09 250M	Up to 9	10	250			0.24
RA 10 300	Up to 10	16	300		0.46		

### Clamps for flat and drop cables (OKPP, OKDP, OKDP with an outer strength member)

	ODWAC	Cable width 2-11 mm	0.08	115-135	Terminal clamp. The body is made of galvanized steel/aluminum alloy.	0.03
	KP-015/ AS-3P	1-5	-	60	The loop is made of chromium-plated steel	-

### Supporting clamps for 8-shapes cables with an outer strength member made of strand, FRP or wire as well as for round coaxial cable

	BAV 3-7	Up to 3-8	2.5	For fastening on CSC 12(S) bracket with a hook	Steel 2 mm. Dimension (9,5x5 cm) in climatic version UHL1 (temperate and cold climate) with coating TD, class 25, type I (coated with zinc)	0.2
--	---------	-----------	-----	--	---	-----

### Earthing connector for 8-way cables with remote element

	CMT 113	3-11		Earthing of insulated and bare supporting steel wires	Corrosion-resistant metal alloy and shielded steel	0.1
---	---------	------	--	---	--	-----

### Tension (non-spiral) clamps for self-supporting dielectric optical cable

	RA 140, FO400 DR-1600-285	from 11-15.3	7	400	High-durable aluminum alloy	UV-resistant polymer	0.35
	RA 190, FO400	from 14-19	7	400			0.6

### Supporting (non-spiral) clamps for a self-supporting optical cable (dielectric, telecommunication and coaxial)

	SMSD ADSS	from 10-20	2	For fastening to the angle	Holder, body, belt: UV-resistant polymer	0.41
	SS 1025B SS 1025D	from 10-20	5	For fastening to CSC 12(S) bracket with a hook		0.1

## Additional elements and instruments for fastening cables:

- Turn-buckle
- Extension socket
- Galvanized shackle
- Galvanized omega-shaped shackle
- Tool with screw mechanism for setting steel tape
- Tool for gripping cable for straining
- Tool for straining cable
- Electronic dynamometer
- Hand cable cutter
- Supporting rollers
- Mounting rollers
- Stainless steel in a container
- Shackle and locks for steel tape

# EQUIPMENT FOR INSTALLATION OF AERIAL OPTICAL CABLES

Appearance	Designation	Cable diameter, mm	Strain, kN	Sets, material	Weight, kg
------------	-------------	--------------------	------------	----------------	------------

## Terminal spiral clamps for self-supporting optical cable, type OKSM, OKSD



Terminal spiral clamps without protector for short spans, 50-60 m					
	DTADSS XS, HCO 1050, 1150, 1250, 1300, 1350, 1450, 1500, 1600, 1700, 1800	10.5-18.8	6	Spiral clamp, Thimble – hot-dip galvanized steel	0.405-0.408

### Terminal spiral clamps with protectors for short spans - 50-60 m. Strength of clamp attachment up to 25 kN



	DTADSS S 1050, 1150, 1250, 1350, 1450, 1510, 1600	10.5-17.0	10-15	Spiral clamp, protector. Bolts: hot-dip galvanized steel. Thimble: hot-dip galvanized steel	1.570-1.735
--	---	-----------	-------	---	-------------

### Terminal spiral clamps with a protector for medium spans. Strength of clamp attachment up to 42 kN

	DTADSS M 1150, 1250, 1350, 1450, 1510, 1600	11.5-17.0	20-24	Spiral clamp, protector. Bolts: hot-dip galvanized steel. Thimble: hot-dip galvanized steel	2.790-3.100
--	---	-----------	-------	---	-------------

### Terminal spiral clamps with a protector for long spans up to 350 m. Strength of clamp attachment up to 85 kN

	DTADSS L 1300, 1370, 1450, 1510, 1560, 1620	13.0-18-1	24-50	Spiral clamp, protector. Bolts: hot-dip galvanized steel. Thimble; hot-dip galvanized steel	5.980-6.100
	DTADSS LS 1950L	19.5-20.5	120		7.650

## Suspension spiral clamps for self-supporting optical, type OKSM, OKSD

### Suspension spiral clamps without protectors for short spans - 50-60 m

	ΠCO 1050, 1150, 1250, 1300, 1350, 1450, 1500, 1600, 1700, 1800	10.5-18.4	6	Spiral clamp, Ring thimble: aluminum alloy	0.190-0.240
--	--	-----------	---	--	-------------

### Suspension spiral clamps with a protector for short spans - 50-60 m

	DTSPR S 1050, 1150, 1250, 1350, 1450, 1510, 1600	10.5-17.0	10-15	Spiral clamp, protector. Bolts: hot-dip galvanized steel. Ring thimble: hot-dip galvanized steel	0.685-0.850
--	--	-----------	-------	--	-------------

### Suspension spiral clamps with a protector for medium and long span

	SAR 90-136 – SAR 166-199 + GSAR + AAR SAR	13.0-18.2	20-50	Clamp body, heavy-duty spiral: albumen alloy; neoprene insert is resistant to extreme climatic conditions. Bolts; of hot-dip galvanized steel	1.970-3.300
	DTSPR M 1250, 1350, 1450, 1560, 1650	12.5-17.5	20-50		2.820
	DTSPR L 1250, 1350, 1450, 1560, 1650	12.5-17.5	120		

### Vibration dampers



	FR 35 "Stockbridge"	15-30 c with protector	Max. value for tightening bolt: 0.4	Hot Dip Galvanized Iron + Aluminum Alloy	2.750
--	---------------------	------------------------	-------------------------------------	--	-------

### Spiral vibration dampers



	PSVD 083 PSVD 117	8.3-11.7 11.7-14.3	Vibration damper, spiral is made of UV-resistant PVC		0.320
--	----------------------	-----------------------	--	--	-------

## Brackets, fasteners:

- Multi-purpose anchor bracket for fastening terminal and suspension clamps. Tension
- Tension brackets for fastening terminal and suspension clamps: SAA 12 (up to 20 kN) and UK-N-01 (up to 10 kN), CASHT
- Bracket for a hook, bracket for suspension clamps for BAV-3-7: CSC 12S (up to 12 kN) and UK-P-02 (up to 2 kN)
- Light-weight bracket with a hook. Bracket for suspension clamps and for BAV-3-7.
- Light-weight bracket for fastening terminal and suspension clamps.
- Tension and suspension units for fastening to the vertical angle of support belt.
- Loop clamps for metal supports and poles.

## OPTICAL FIBER CLOSURES FOSC-400

FOSC-400 closures are designed for splicing building lengths and / or for carrying out branches of optical cable installed in cable ducts, collectors, tunnels, soils of all categories (except rocky and permafrost), suspended on poles of power lines, contact network and auto-lock railways.

Coupling	Number of fiber joints			Number of structural elements		
	Single welding	Single mechanical connection	4-fiber tape	Loose tubes	Loose laying of optical fibers	12-fiber tape
FOSC 400 A4	48/96	24(4)	24	8	96	6
FOSC 400 A8	96	48	288	6	96	24
FOSC 400 B2, B4	96/144*	96/144*	288	6	96	24
FOSC 400 D5	768	768	1152	18	96	72

\*The closures capacity can be increased to 144 splices when two additional cassettes are installed in place of the tray for storing transit modules (fibers).

**Additional cassettes can be installed in the manufacture of the closures! It is not possible to install additional cassettes in an already mounted closures!**

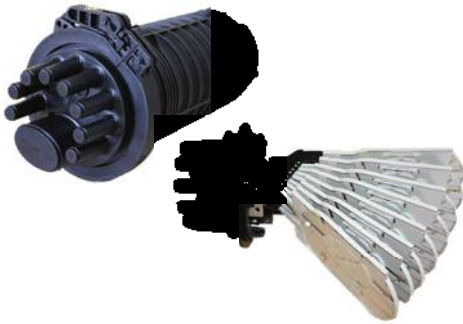

**FOSC 400 A4** optical closures are designed for installation on air supports, in cable ducts and directly in the ground. Sealing the case with a mechanical lock simplifies installation and opening of the coupling. 2 modifications of the FOSC-400 A4 closures are delivered - on 2 and on 4 splice cartridges.

**FOSC-400 A8** optical closures are identical in size to the FOSC-400A4 closure, but has 8 round cable entries. In it, you can install up to 4 cassettes with 24 fibers or 8 with 6 fibers. The diameter of the cable is 5-10mm (round entry for modification A8) or 4-18mm (round entry for modification A4), 10-25mm (oval).



**The optical closure FOSC 400 B2 and FOSC 400 B4** differ only in cable entry configurations - the B2 closure has 2 large, and the B4 closures - 4 small round water. In one round bushing of sleeve B2, 2 cables can be inserted at the same time using the BOCL splitter terminal. Number of cable ports: 2 or 4 round + 1 oval.

Cable diameter: 5-19mm (up to 32 for B2) - round entries, 10-25mm oval. These closures can be ordered with 1 splice cassette or with six. Up to 3 cassettes can be installed in a closure with 1 cartridge! Closures with 6 cassettes differ structurally and are ordered separately.



**FOSC-400 D5** optical closures are the largest in the FOSC-400 series. Up to 7 cables can be inserted into it (up to 12 cables using the BOCL splitter terminal). Splice cassettes for connecting and laying fibers in the FOSC-400D5 contain interchangeable connecting modules designed on a different number of compounds. In each cartridge 6 connecting modules are installed. The number of splice cassettes in the coupling: 8 cassettes for 36, 48, 72 or 96 connections. Capacity: up to 768 fibers (8 x 36, 48, 72 or 96). Number of cable ports: 4 round + 1 oval.

Cable diameter (mm): 5-32 (round bushing), 10-25 (oval bushing).



## OPTICAL DISTRIBUTION FRAMES

### Optical distribution frames of rack type, series KS 19-21"

Type KS is manufactured with height of 1U, 2U, 3U, 4U; frames are designed for 24, 48, 96, 144 ports respectively. They are assembled in various sets - from 4 to 288 ports. They may be equipped with stationary as well as changeable modules (panels); the latter are designed for 4 and 8 ports. Eight ports can be with modules-plugs. There is a removable shelf in the set of the distributing frame. It is possible to install patch panels of various types into one box, including those ones for 4 ports and couplings.

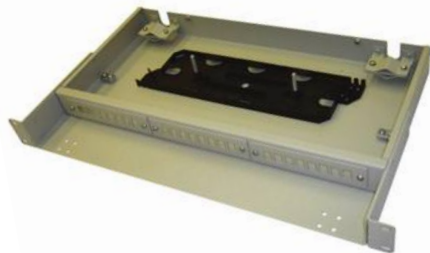

- Possibility of replacement the bracket 19" for bracket 21";
- Direct cable input which makes it possible to input up to 4 cables into single-unit body;
- Splice cassette K-10 is installed into the body; the capacity of the cassette is 16 fusion connections; the cassette is closed with a metal cover for protection;
- The set includes cable ties and platforms instead of standard organizers which makes it possible to lay out cable more convenient.

Model	Dimensions, mm	Amount	Number of cable ports	Weight
KS-24-1U KSu-24-1U	410x220x44 without shelf 410x285x44 With a shelf 412x220x44 - KSu	4-24	2	Up to 2.7kg
KSu-48-2U	410x220x48 without a shelf 410x285x84 with a shelf	4-48	4	Up to 3.7 kg
KSu-96-3U	410x220x132 without a shelf 410x285x132 with a shelf	4-96	6	Up to 4.1 kg
KSu-144-4U	410x266x176	16-144	6	Up to 5.0 kg

### Optical distribution frames of rack type, series KSu.

- Installation of patch panels with the use of plastic clips which makes replacement and cleaning of adapters.
- Multi-purpose cable input of box type which makes possible to reduce losses when connecting cable.
- The brackets are fastened on runners which make possible to put the distributing frame inside the rack.

### Sliding distribution frame of rack type, series KSv.

Type KSv is manufactured with height 1U and 2U and is designed for 16, 24, 32 and 48 ports.

- Sliding base which makes assembly and check-up of connections easier. It is needless to pull-out equipment available inside from the rack in his version.
- It offers selection between stationary and changeable patch panels (the stationary panel is for 24 and 48 ports, changeable panel is for 16 and 32 ports respectively).
- There is a lock which makes possible to securely protect the distribution frame from outside interference.



Model	Dimension, mm	Number of ports	Number of cable inputs	Weight
<b>KSv-16-1U</b>	432x300x44	16	2	Up to 3.2 kg
<b>KSv-24-1U</b>	432x300x44	24	2	Up to 3.2 kg
<b>KSv-32-2U</b>	432x300x88	32	4	Up to 4.0 kg
<b>KSv-48-2U</b>	432x300x88	48	4	Up to 4.0 kg

### Wall-type distribution frames, series KN, assembled, from 4 to 96 ports.

There are six basic models - KN-8, KNz-8, KH-16, KN-32, KH-48, KN-96. Except KN-8 (type MINI), all frames are equipped with locks. KN-16, KN-32, KN-48, KN-96 are with changeable modules or plugs.

- There is a flap side for easier assembly.
- It is possible to install patch panels of various types in one body, including modules with 4 ports and plugs.



Model	Dimensions, mm	Number of ports	Number of cable inputs	Weight
<b>KN-mini</b>	163x50x123	4-8	1	Up to 0.7 kg
<b>KNz-8</b>	268x68x230	4-8	2	Up to 1.7 kg
<b>KN-16</b>	350x60x305	4-16	2	Up to 2.0 kg
<b>KN-32</b>	330x75x330	4-32	4	Up to 2.7 kg
<b>KN-48</b>	350x105x330	4-48	4	Up to 4.0 kg
<b>KN-96</b>	350x135x435	8-96	4	Up to 5.5 kg



## OPTICAL CORDS, PIGTAILS, CABLE ASSEMBLIES

- Optical cords (patch cords) with FC, SC, ST, LC connectors in single-mode and multimode designs • Optical cords (pigtails) with FC, SC, ST, LC connectors in single-mode and multimode designs
- Optical adapters FC, SC, ST, LC in single-mode and multi-mode design
- Cable assemblies with various types of optical cables: OKPM, OKPTS, OKKM, OKKTS, OKTM, OKTTS, OKPP, OKSTS, OKDP, OKR, etc.
- Sleeves KDZS-60, KDZS-40, AG-61S, AG-45S to protect the place of welding of fibers.



## MEASURING EQUIPMENT



**Yokogawa AQ7280** optical modular system OTDR - the latest manual modular platform designed for fast and efficient testing of optical networks. Large screen with multi-touch screen + full dubbing of button controls, PON-optimization, the ability to connect many options, there is a module for multi-mode, can be used with a video probe to assess the quality of ferrules connectors. The specially developed design and advanced Yokogawa AQ7280 software make it possible to measure in PON networks on splitters up to 1x128, and the dynamic range increased up to 50 dB helps to test trunk lines.



**Yokogawa AQ1000** optical reflectometer - compact, lightweight and economical. It has a "one button" mode, in which measurements are made in a fully automatic mode, analysis of the results obtained with passing the Pass / Fail test and recording the results. Despite its simplicity, it has high performance - boot time less than 10 seconds, a modern 5-inch color touch screen and a capacious battery with a battery life of at least 10 hours.



**The source of optical radiation Grandway** is a budget model, pre-assigned for testing optical networks. It can work in continuous or modulated mode, providing high radiation stability. The device has small dimensions and weight and is great for working inside and outside buildings. It is equipped with a fixed optical port FC / PC for two wavelengths of 1310, 1550 nm.



**Optical tester Grandway FHM2A01** - designed to measure insertion loss in the optical fiber, combines a radiation source for 2 wavelengths 1310 / 1550nm and a broadband power meter. Thanks to the compact size and rich functionality of the tester, it is convenient to use. The measurement results can be stored in the device memory (up to 999 entries). Measurement range from -70 to +10 dBm. Measurement accuracy  $\pm 5\% \pm 1$  nW.



**Grandway FHP-A12** optical power meter is a miniature optical power meter designed for use in telecom networks. Calibration wavelengths 850/1300/1310/1490/1550/1625 nm, dynamic range 70 ~ +10 dBm (at a wavelength of 1550 nm). Weight 70g.



**Optical Time Domain Reflectometer Anritsu MT9083A / B / C ACCESS Master™** - allows installation of fiber optic lines (including PON networks), maintenance of FTTx, CATV, LAN, optical access networks and optical city networks.

# MOSKABEL-FUJIKURA

## HEAD OFFICE:

Address: 111024, Moscow, 2 Kabelnaya 2/2.

Phone: +7 495 109 0988

E-mail: [mk-f@mk-f.ru](mailto:mk-f@mk-f.ru)

Web: [mk-f.ru](http://mk-f.ru)

## SALES DEPARTMENT:

Tel .: +7 495 109-09-88

E-mail: [sale@mk-f.ru](mailto:sale@mk-f.ru)

[petrikovva@mkm.ru](mailto:petrikovva@mkm.ru) (English)

## LOCATION MAP

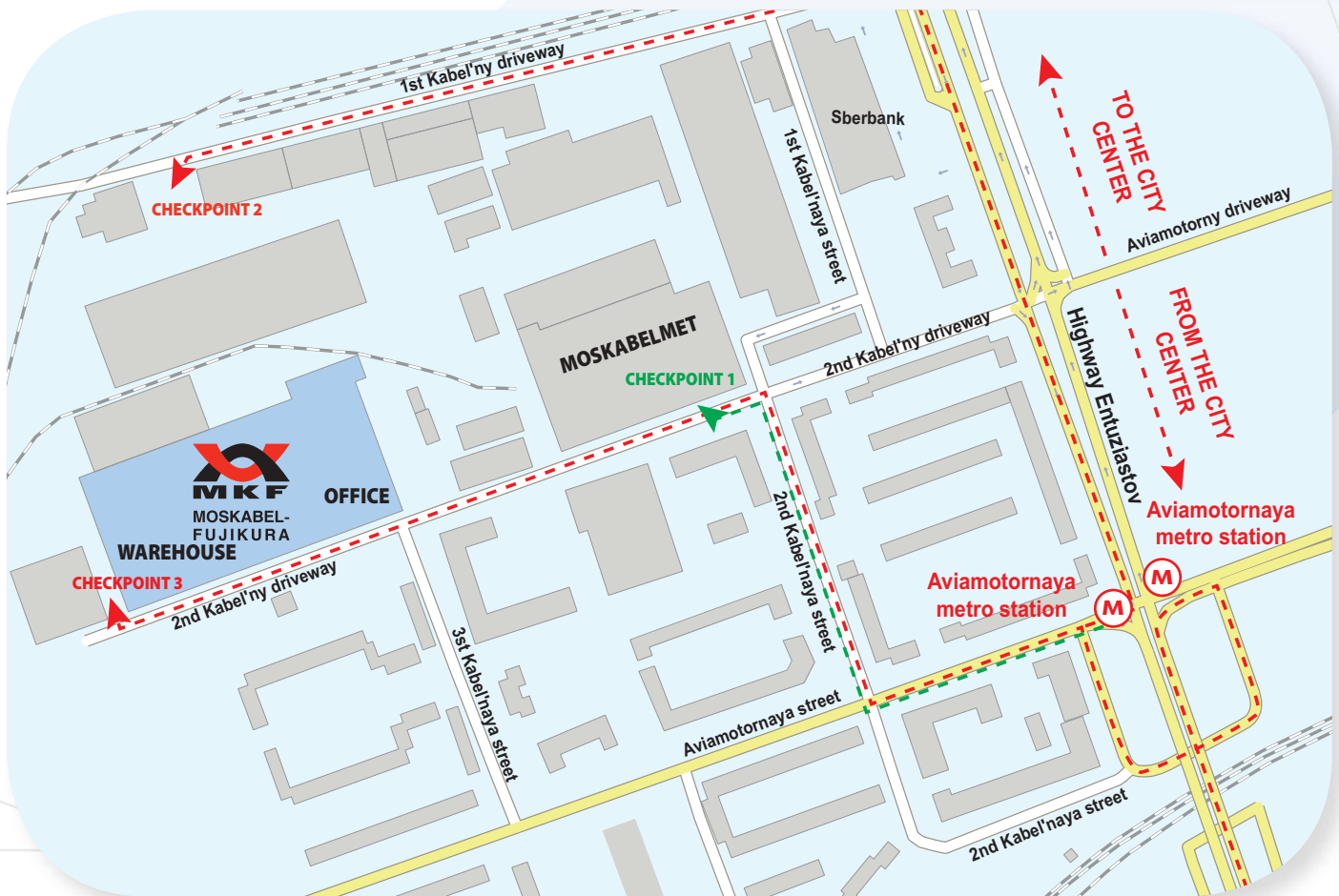



**111024, Russia, Moscow, 2 Kabelnaya 2/2**

**Tel.: +7 495 109 09 88**

**E-mail: [mk-f@mk-f.ru](mailto:mk-f@mk-f.ru)**

**Web: [mk-f.ru](http://mk-f.ru)**